

ENGLISH FOR TODAY

Dakhil Class Eight



National Curriculum and Textbook Board, Bangladesh

Prescribed by the National Curriculum and Textbook Board as
a textbook for Dakhil class eight from the academic year 2013

ENGLISH FOR TODAY

Dakhil
Class Eight

Revised for the year 2025

Published by
National Curriculum and Textbook Board
69-70, Motijheel Commercial Area, Dhaka

[All rights reserved by the Publisher]

First edition written and edited by

Abdus Subhan

M S Hoque

Yasmin Banu

Surajit Roy Majumder

Md Abdur Razzaque

Naina Shahzadi

Nargis Akhter Banu

First Publication : September 2012
Revised Editon : September 2014
Revised Editon : November 2020
Revised Editon : October 2024

For Free Distribution by the Government of the People's Republic of Bangladesh

Printed by :

Preface

The importance of formal education is diversified. The prime goal of modern education is not only to impart knowledge but rather to build a prosperous nation by developing skilled human resources. At the same time, education is the best means of developing a society that is free from superstitions and adheres to science and facts. To stand as a developed nation in the science and technology-driven world of the 21st century, we need to ensure quality education. A well-planned education is essential for enabling our new generation to face the challenges of the age and to motivate them with the strength of patriotism, values, and ethics. In this context, the government is determined to ensure education as per the demand of the age.

Education is the backbone of a nation and a curriculum provides the essence of formal education. Again, the most important tool for implementing a curriculum is the textbook. The National Curriculum 2012 has been adopted to achieve the goals of the National Education Policy 2010. In light of this, the National Curriculum and Textbook Board (NCTB) has been persistently working on developing, printing, and distributing quality textbooks. This organisation also works to review and revise the curriculum, textbooks, and assessment methods according to needs and realities.

Secondary education is a vital stage in our education system. This textbook is catered to the age, aptitude, and endless inquisitiveness of the students at this level, as well as to achieve the aims and objectives of the curriculum. It is believed that the book written and meticulously edited by experienced and skilled teachers and experts will be conducive to a joyful experience for the students. It is hoped that the book will play a significant role in promoting creative and aesthetic spirits among students along with subject knowledge and skills.

Due to globalization, rapid communication, and digitalization, the need and importance of English is increasing. English is one of the powerful tools for pursuing higher study, using technology, developing interpersonal communication, and accessing local and global job markets. The curriculum makes it explicit that language learning will be graded and contents will replicate real-life contexts to enhance language learning for communication. The English For Today textbooks have been developed to help students attain communicative competence in English with particular attention to the development of the four language skills i.e. listening, speaking, reading and writing.

It may be mentioned here that the textbook has been reviewed and revised for the academic year 2025. It is mentionable here that the last version of the textbook developed according to the curriculum 2012 has been taken as the basis. Meticulous attention has been paid to the textbook to make it more learner-friendly and free from errors. However, any suggestions for further improvement of this book will be appreciated.

Finally, I would like to thank all of those who have contributed to the book as writers, editors, reviewers, illustrators and graphic designers.

October, 2024

Prof. Dr. A K M Reazul Hassan

Chairman

National Curriculum & Textbook Board, Bangladesh

Contents

Unit	Title	Pages
Unit 1	A Glimpse of Our Culture	1-11
Unit 2	Food and Nutrition	12-18
Unit 3	Health and Hygiene	19-32
Unit 4	Check Your Reference	33-42
Unit 5	Humans and Environment	43-58
Unit 6	Going on a Trip	59-76
Unit 7	People and Occupations	77-90
Unit 8	News! News! News!	91-109
Unit 9	Things that Have Changed Our Life	110-128
Unit 10	Fables	129-137
Unit 11	Women's Role in Uprisings	138-141
	Sample Question	142-160

Unit One

A Glimpse of Our Culture

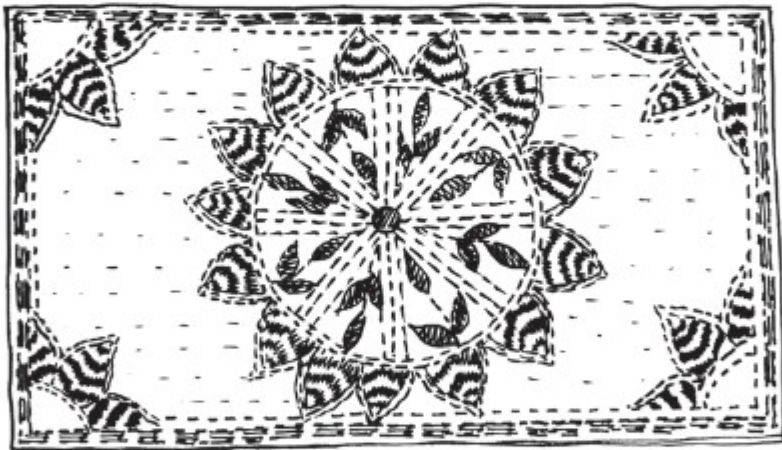
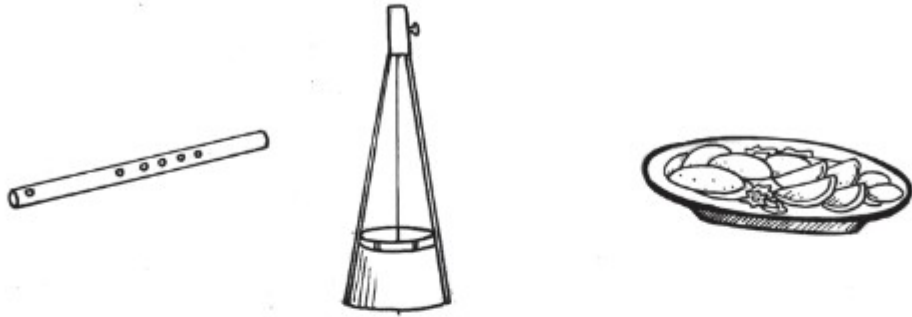

After we have studied this unit, we will be able to

- read and understand texts through silent reading
- infer meaning from context
- ask and answer questions
- write answers to questions
- write short compositions

Lesson 1: People's Music



A set of four stamps issued on 21 July 2011 on Traditional Musical Instruments of Bangladesh

Key Words

People's music, oral tradition, self-expression, instruments, migration

A. Work in Pairs

1. What kinds of music do you hear in your daily life? Are they related to your family traditions or culture?
2. How do you think music changes over time? Does it stay the same, or does it evolve with people's lifestyles?
3. Can you think of any traditional instruments you've seen or heard about? What materials do you think they're made from?
4. Why might certain types of music become less common as people move from villages to cities?

B. Read the text and answer the following questions.

People's music, also known as folk music, consists of tunes, lyrics, and knowledge passed down orally for generations. Over time, this music has evolved, closely tied to the way people live. Our agriculture, food, ecology, seasons, and rituals are all reflected in these songs. Palligiti, Bhatiwali, Jari, Sari,

Gambhira, Lalon Giti, Paalagan, and the songs of Hason Raja all embody the self-expression of the people.

As the landscape changes, the music shifts too. In the hill tracts, you encounter music with the same role but expressed in the diverse languages of the ethnic communities. The instruments used for folk music are crafted from materials found in the surroundings—animal skin, bamboo, and calabash are common examples. The sounds they produce are deeply connected to the land they come from. As people migrate to cities and villages transform, these traditional tunes are slowly fading. However, folk music still finds its place in mainstream films and music albums.

The following are translations of a Hason Raja song and a Bhawaiya song featured in the film *Asiya*, directed by Fateh Lohani:

Translation of Hason Raja's Loke Bole Bole Re (Oh, They Say)

*Oh, They say my house is no good,
But what can I build with nothing here?
I'll erect a home,
Yet how long will I truly stay?
I gaze into the mirror,
Noticing the strands of grey in my hair.
Thinking of this,
Hason Raja never built a dwelling.
Where will Allah take him? Where will he find rest?
This uncertainty brings him to tears.
If only Hason Raja had known his days,
He would have painted his rooms in vibrant hues.
Oh, They say my house is no good,
But what can I build with nothing here?*

Listen to the Bhawaiya song on the internet the as featured in the film *Asiya* and sung by Mustafa Zaman Abbasi and Ferdousi Rahman:

Questions

1. What are some examples of Bangladeshi folk music genres mentioned in the passage?
2. How are the instruments used in folk music connected to the land and environment?
3. What happens to folk music as people move to cities and villages change?
4. How is Bangladeshi folk music still present in mainstream media, despite its decline?

C. Discuss in groups and write a paragraph on the following topic:

How has Bangladeshi folk music changed over the years, and what is its importance in everyday life and culture today?

Lesson 2: Nakshi kantha

Key words : quilt artistic commercially traditional demand pattern

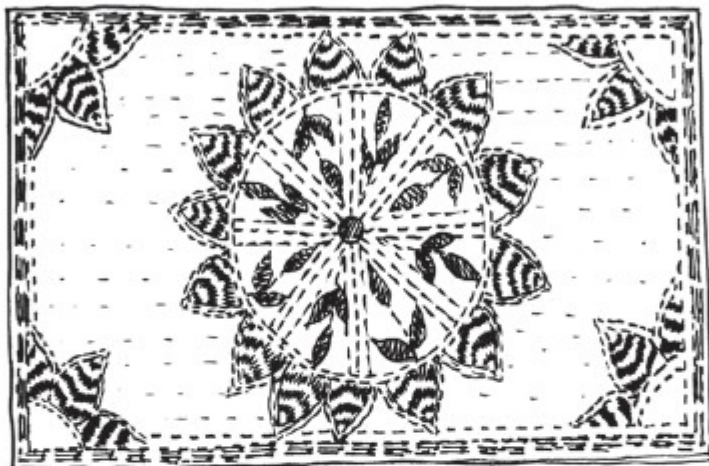

A Look at the picture and the questions. Then ask and answer the questions with your partner.

- 1 What do you see in the picture?
- 2 What is it called?
- 3 Have you seen it before? Where?
- 4 What do we do with it?

B Excerpt from The field of the embroidered quilt by Jasimuddin:

Spreading the embroidered quilt,
 She works the livelong night,
 As if her poet were
 On his bereaved plight.
 Many a joy and many a sorrow
 Is written on her breast;
 The story of Rupai's life is there,
 Line by line expressed.
 "How will he bear the pain, mother?"

On this quilt lies all of mine—
 All my pain and my grief,
 Embroidered line by line.
 So lay it on my grave, mother.
 This picture of my grief,
 That his and mine upon its breast
 May mingling find relief.

Translation: E. M. Milford

C Now, read the text to know about Nakshi kantha.

Nakshi kantha is a kind of embroidered quilt. The name was taken from the Bangla word, '*naksha*' which means artistic pattern. It is a kind of traditional craft and is said to be indigenous to Bangladesh and West Bengal in India. The art has been practised in rural Bengal for centuries. The name *Nakshi Kantha* became popular after the poet Jasimuddin's poem '*Nakshi Kanthar Math*' was published in 1929.

Traditional *kanthas* are made for family use. Old or new cloth and thread are used to make these quilts. Mymensingh, Jamalpur, Rajshahi, Faridpur, Bogura and Jashore are most famous for this craft. Now it is produced commercially. You can find them in many expensive handicraft shops in cities. The quilts are now in great demand because of the colourful patterns and designs embroidered on them.

D Complete the sentences with clues given. There are more words than necessary.

Bengali patterns embroidery years fashion art rural designs quilt <i>naksha</i>

- Naksha* means artistic
- The name was taken from a word
- The art has been practised in Bengal for
- Nakshi kanthas* are now sold in shops.
- Nakshi kanthas* are in great demand because of their colourful and
- Nakshi kanthas* are a kind of

E Write down five questions for the completed statements in Activity E above.

One is done for you.

- What does *naksha* mean ?

F Do you like a *Nakshi kantha* or an ordinary *kantha*? Why?

G Work in pairs. Ask and answer all the questions in Activity. Now, write 3-4 more questions on the text given in Activity B above.

H Write a Paragraph describing how the *Nakshi kantha* is made. Start like this: Old or new cloth and coloured thread are needed. First the cloth is folded, then.....

Lesson 3: Our Ethnic Friends

A. Look at the picture. Then discuss the following questions in pairs.

1. What do you see in this picture?
2. Can you read the caption?
3. What does it mean?



Artwork by Joydeb Roaja of an Indigenous woman, emphasizing her deep connection to nature and the environmental wisdom she holds.

B. Now, read the text.

Bangladesh is home to more than 54 Indigenous groups, including the Chakma, Marma, and Tripura, with most living in the northern and southeastern flatlands, and the rest in the Chittagong Hill Tracts. They have distinct lifestyles, economic practices, and belief systems. These groups speak at least 35 distinct languages, adding to the country's cultural richness. However, many of these languages are endangered, as the dominance of Bangla and modern societal pressures push them towards extinction, a global issue known as "language death." The UN warns that many Indigenous languages are disappearing, with one dying every two weeks.

During the British colonial rule, indigenous communities played a significant role in resisting oppression. Leaders like Sidhu and Kanu led uprisings, such as the Santhal Rebellion, highlighting their contributions to the anti-colonial struggle. Despite this legacy, Indigenous people in Bangladesh today face challenges in preserving their languages and culture. The government's efforts to include Indigenous languages in preschool education face hurdles like a lack of trained teachers and resources for higher education.

Additionally, the 1957 construction of the Kaptai Dam, funded by USAID and built by the Pakistani government, displaced thousands of people in the hill tracts, submerging their homes and farmlands under the Karnaphuli River, disrupting their livelihoods and cultural connections to the land. This history of displacement and ongoing marginalization continues to affect indigenous communities in Bangladesh.

C. True or False? If False, give the correct information.

1. Bangladesh is home to more than 54 indigenous groups, including the Chakma, Marma, and Tripura.
2. Indigenous groups in Bangladesh speak only a few languages, with most of them being well-preserved.
3. The dominance of Bangla has helped preserve indigenous languages in Bangladesh.
4. Sidhu and Kanu were leaders of uprisings during the British colonial period.
5. The Kaptai Dam, built in 1957, displaced thousands of people in the hill tracts, disrupting their connection to the land.

D. Ask and answer the questions in pairs.

1. In which part of Bangladesh do most indigenous groups live?
2. How many distinct languages do Indigenous groups in Bangladesh speak?
3. What global issue is related to the decline of indigenous languages?
4. What organization warns that many Indigenous languages are disappearing?
5. What has made it difficult for indigenous people to preserve their languages today?

Lesson 4: Bangladeshi Cuisine

Key words : cuisine platter molasses

A Look at the pictures and discuss in pairs.

1. What do you see in the pictures?
2. Which foods are seen in the pictures? Do you prepare/eat them at home?
3. Among the foods, which one is your favourite? Why?

B Read the text below and answer the following True-False Activity in section C.

Bangladeshi cuisine is rich and varied with the use of many spices. We have delicious and appetizing food, snacks and sweets.

Boiled rice is our staple food. It is served with a variety of vegetables, curry, lentil soups, fish and meat. Fish is the main source of protein. Fish are now cultivated in ponds. Also we have fresh-water fish in the lakes and rivers. More than 40 types of fish are common. Some of them are *carp*, *ru*, *katla*, *magur* (catfish), *chingri* (prawn or shrimp). *Shutki* or dried fish are popular. *Hilsha* is very popular among the people of Bangladesh.

Panta ilish is a traditional platter of Panta bhat. It is steamed rice soaked in water and served with a fried hilsha slice, often together with dried fish, pickles, lentil soup, green chilies and onion. It is a popular dish on the Pohela Boishakh.

The people of Bangladesh are very fond of sweets. Almost all Bangladeshi women prepare some traditional sweets. Pitha, a type of sweets made from rice flour, sugar, syrup, molasses and sometimes milk, is a traditional food loved by the entire population. During winter *Pitha Utsab*, meaning *pitha* festival, is organized by different groups of people.

Sweets are distributed among close relatives when there is good news like births, weddings, promotions, etc.

Sweets of Bangladesh are mostly milk-based. The common ones are *roshgolla*, *sandesh*, *rasamalai*, *gulap jamun*, *kalo jamun* and *chom-chom*. There are hundreds of different varieties of sweet preparations. Sweets are therefore an important part of the day-to-day life of Bangladeshi people.

C True or false? If false, give the correct information.

- 1 Our food is rich because it have a lot of oil in them.
- 2 We get protein mostly from fish.
- 3 On *Pohela Boishakh*, the traditional food is steamed rice and fried *hilsha*.
- 4 *Pitha Uthsab* takes place almost all the year round in Bangladesh.
- 5 Sweets are not much appreciated by the people of Bangladesh.

D Read the text in B again and answer the following questions.

- 1 What has made Bangladeshi food so special?
- 2 Where do we get the fish from?
- 3 Apart from fish, what other foods do we eat with rice?
- 4 Why are sweets an important part of our life?

E Discuss and answer the questions in pairs.

- 1 Describe a Bangladeshi food item that you like best.
- 2 Make a list of the things you and your partner eat every day.
- 3 Make two lists of food item one eaten by the urban and the other by the rural people.
- 4 Why are there differences between the food eaten by the urban and the food eaten by the rural people?

F How fast can you say this sentence?

Casual clothes are provisional for leisurely trips across Asia.

Lesson 5: The Children's Songs

A Read and recite the poem.

The Children's Songs

Land of our Birth, we pledge to thee
Our love and toil in the years to be;
When we are grown and take our place
As men and women of our race.

Father in Heaven, Who lovest all,
Oh help Thy children when they call;
That they may build from age to age,
An undefiled heritage.

Teach us to bear the yoke in youth,
With steadfastness and careful truth;
That, in our time, Thy Grace may give
The Truth whereby the Nations live.

Teach us to rule ourselves always,
Controlled and cleanly night and day;
That we may bring, if need arise,
No maimed and worthless sacrifice.

Teach us to look, in all our ends,
On Thee for judge, and not our friends
That we, with Thee, may walk uncowed
By fear or favour of the crowd.

Teach us the strength that cannot seek,
By deed or thought, to hurt the weak;
That, under Thee, we may possess
Man's strength to comfort man's distress.

Teach us Delight in simple things,
And Mirth that had no bitter springs;
Forgiveness free of evil done,

And Love to all men, 'neath the sun!
Land of our Birth, our faith, our pride,
For whose dear sake our fathers died
Head, heart and hand through the years to be!

- Rudyard Kipling

Word notes :

pledge : make a promise

toll : hard work

lovest : love

thy : your

undefiled : pure

heritage : the history, traditions, buildings and qualities that a country has had for many years and that are an important part of the country's character

yoke : a piece of wood that holds two oxen together, while ploughing or pulling a cart

bear the yoke : shoulder the great responsibility

B Read the poem silently and answer the questions.

- 1 What do the children promise to their motherland?
- 2 What do the children ask God to teach them?
- 3 Do you like the poem? Why?

Unit Two

Food and Nutrition

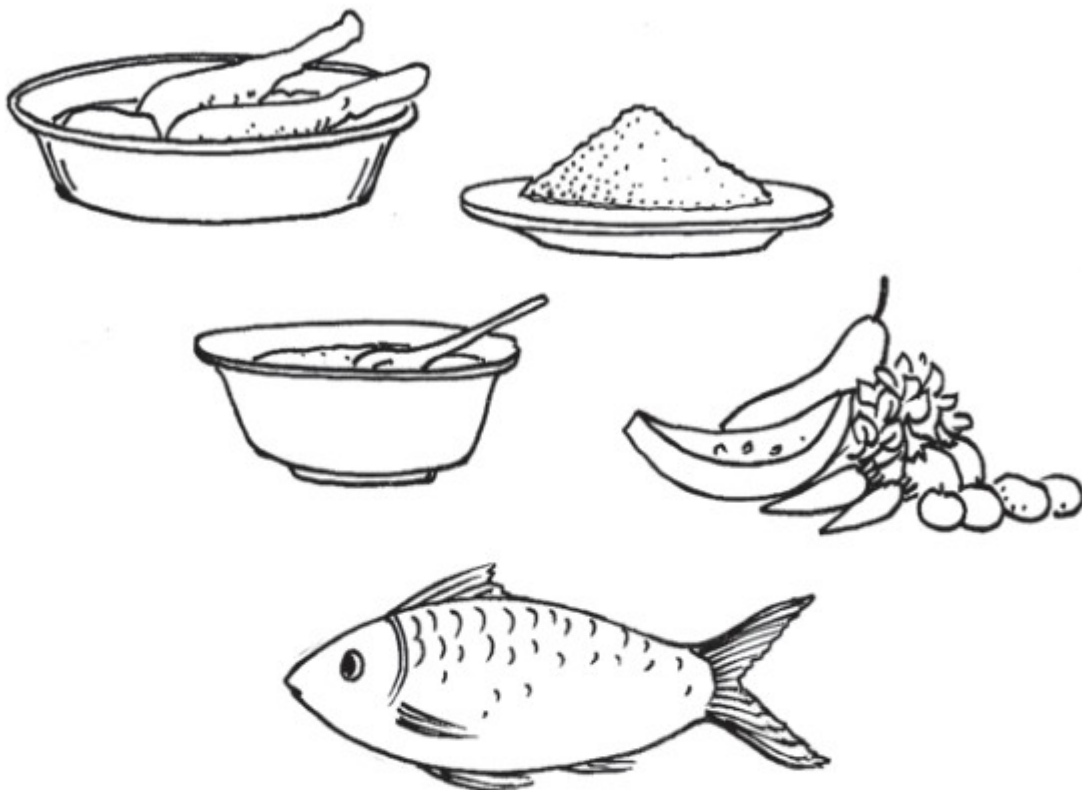

After we have studied this unit, we will be able to

- read and understand texts through silent reading
- listen for information
- ask and answer questions
- write answers to questions
- practise sounds

Lesson 1: Good Food

Key words : nutritious substances physical structure

A Talk about the picture and read the text.

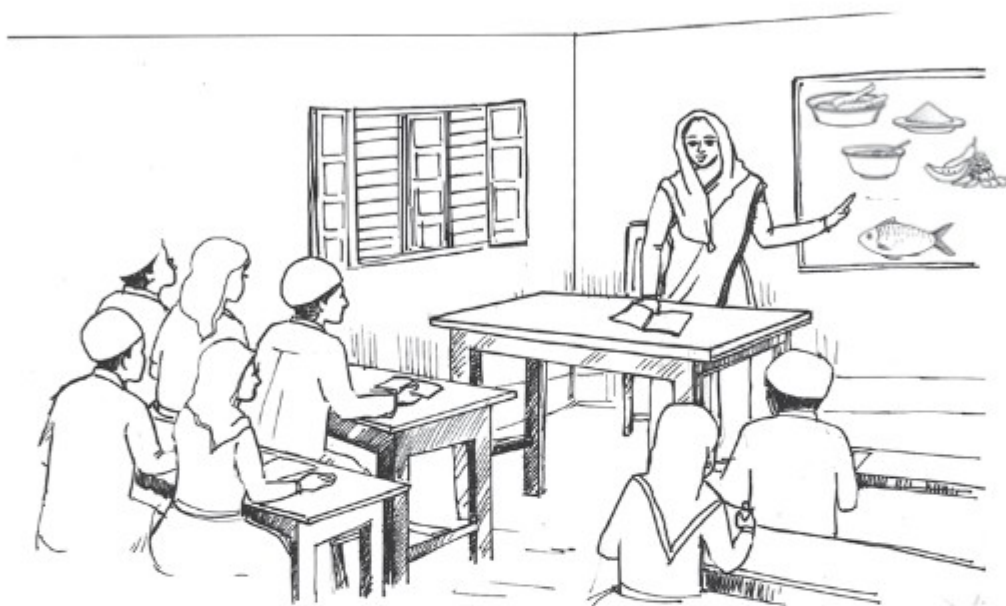

Ms Rehana, the English teacher, is talking to the class about food.

“Food is very important for our body,” she says. “We can’t live without it. So you must always have good food.”

“What’s good food, teacher?” asks a student.

“Good food means the right kind of food for good health,” says Ms Rehana. “It is nutritious. It must contain natural substances that our body needs to grow properly and stay healthy. But remember, you must not eat too much though the food is good. Eating too much is bad for health. You have to eat only a certain amount of food that your body needs. So we do not need the same kind of food in the same quantity. It depends on your growth and physical structure”.

B Answer the following questions.

- 1 What is Ms Rehana talking about?
- 2 Why do we eat food?
- 3 What is meant by 'nutritious food'?
- 4 How much food does a person need to eat a day?
- 5 Does everyone need the same amount of food? Why?

C Complete these sentences.

- 1 We should eat good food to _____.
- 2 We should not eat more than _____.
- 3 Eating too much food is not _____.
- 4 Good food means _____.

Lesson 2: Kinds of Food

Key words : Carbohydrate Protein Vitamins Minerals

A Listen to the teacher/CD and answer the following questions.

U2, L2 A
Listening text: 1

Questions

- 1 How many kinds of food do we need?
- 2 What are they?

Now, choose the best answer.

1 Foods are divided into classes according to their

- | | |
|----------------------------|-----------------------|
| a colours and tastes. | b shapes and sizes. |
| c substances they contain. | d water they contain. |

2 Potatoes contain a lot of

- | | |
|-----------------|-------------|
| a carbohydrate. | b protein. |
| c vitamins. | d minerals. |

- 3 Butter and ghee are a good source of**
- a protein. b fat.
c vitamins. d carbohydrate.
- 4 Minerals are present in**
- a nuts. b peas.
c milk. d water.
- 5 Which food has the most carbohydrate?**
- a Sugar b Rice
c Fruits d Vegetables

Lesson 3: Our Daily Diet

Key words: essential disease calcium interval

A Read the dialogue.

Ms Rehana : Let's talk about some essential foods that we need to eat regularly.
For our good health we must choose the right food in our daily diet.

Student 1 : We eat rice, '*ruti*', fish and meat every day. What else should we have, teacher?

Ms Rehana : Well, we must also eat vegetables and fruits. They contain a lot of vitamins and minerals. They keep our body free from diseases. They are also good for our skin and overall health.

Student 2 : Should we have anything else?

Ms Rehana : Sure. We need to drink milk everyday. Milk is highly rich in calcium. It's good for our healthy growth. It makes our bones and teeth strong as well. We must drink pure water at regular intervals too. It's essential for our body. We can't live without drinking water.

B Make five questions from the following table.

Why	do	essential for our body?
What	are	good for our skin?
What foods	is	we need to eat good food?
		vegetables contain?
		minerals do to us?

C Now, write the answers to the questions that you have made in section B.**D Read the text in section A again and tick the best answer.**

- 1 Milk is highly rich in fat/calcium/sugar.
- 2 Fruits and vegetables are good for eyes/ general health/ teeth.
- 3 Water/energy drink/milk is most important for life.

Lesson 4: A Delicious Dish

Key words : custard peel

A Look at the pictures. What do you see there?**B Ask and answer the questions.**

- 1 What type of food do you like?
- 2 Why do you like these?
- 3 Where do you get these from?
- 4 Do you eat home-made food?

C Look at the picture. What do you see in the bowl?

Now, read the following recipe.

Ingredients:

- 1 Ripe banana: 1
- 2 Apple: 1
- 3 Ripe papaya: 1 (small)
- 4 Custard powder: 2 tablespoons
- 5 Milk: half litre
- 6 Sugar: 4 tablespoons

How to prepare

First wash the fruits and peel them. Then cut the fruits into small pieces and keep them in a bowl. Now boil the milk in a pot. Next mix sugar with it and stir well. Take the custard powder in a small cup, put 4 tablespoons of cold milk and mix well. Now pour the mixture into the boiling milk and stir well. Boil for five minutes, stirring it all the time. After that, take the pot off the stove. Let the custard cool. Finally pour it into the fruit bowl. Now, the delicious custard is ready to eat.

D Describe how to make a cup of tea using the following sentence connectors.

First	Then	Next	After that	Finally
-------	------	------	------------	---------

Lesson 5: A little Plant

Key words : bury, sprout

A Talk about the picture.

Then read and listen to the poem.

A Little Plant

In the heart of a seed
Buried deep, so deep,
A dear little plant
Lay fast asleep.
“Wake!” said the voice
Of the rain drops bright.
The little plant heard.
And rose to see
What the wonderful
Outside world might be.



B As you listen to the poem, notice how these groups of words are pronounced. Practise saying these words.

- 1 seed, deep, asleep, see
- 2 heard, world
- 3 lay, wake, rain

C Ask and answer the questions.

- 1 Where is the little plant sleeping ?
- 2 Who spoke to the little plant ?
- 3 What did they want the little plant to do?
- 4 What two things do plants need in order to grow ?
- 5 Which word in the poem means “grow” ?

Unit Three

Health and Hygiene



After we have studied this unit, we will be able to

- read and understand texts through silent reading
- listen for information
- ask and answer questions
- write the answers to questions
- practise sounds
- write paragraphs/ compositions

Lesson 1: Health

Key words : disease essential concentrate possession

A Look at and talk about the picture. Ask and answer the following questions.



- a. How often do you wash hands?
- b. Why do you wash hands?

B Read the questions first. Then read the text and answer the questions.

- 1 Why is good health essential for us?
- 2 Why is physical exercise necessary?

Health is the condition of our body and mind. It may be good or bad. Good health means healthy body free from diseases. It is essential for everyone to lead a happy life. If we are not in good health, we cannot concentrate on any activity in our life.

A proverb goes, "Health is Wealth" It means health is equally valuable as gold or any other personal possessions. We may have vast wealth and property, but if we are not healthy we cannot enjoy them.

To keep ourselves healthy, we have to do certain things. We have to take a balanced diet. We must exercise regularly to keep our body fit for work. There is an old saying: 'Early to bed and early to rise makes a man healthy, wealthy and wise.' So, we should not keep late hours. We should go to bed early at night and rise early in the morning. Peace of mind is another condition for good health. So we must not worry over small things of life.

C Read the text in B silently and then choose the best answer.**1 Health means the condition of**

- | | |
|-----------------------|---------------------|
| a. our body. | b. our mind. |
| c. our body and mind. | d. our environment. |

2 A healthy person is one who

- | | |
|--------------------------------------|--------------------|
| a. is physically and mentally sound. | b. eats good food. |
| c. has a lot of wealth. | d. is overweight. |

3 We need to eat

- | | |
|-----------------|-------------------|
| a. rich food. | b. balanced food. |
| c. little food. | d. lot of food. |

4 The phrase 'to keep late hours' means

- | | |
|------------------------------|------------------------------------|
| a. to go to bed late. | b. to wake up late in the morning. |
| c. to do things late always. | d. to be late for the class. |

D Write a short paragraph about how you can maintain good health within 180-200 words.**Lesson 2: Ode on Solitude****A Read and recite the poem.****Ode on Solitude**

Happy the man, whose wish and care
 A few paternal acres bound,
 Content to breathe his native air,
 In his own ground.

Whose herds with milk, whose fields with bread,
 Whose flocks supply him with attire,
 Whose trees in summer yield him shade,
 In winter fire.

Blest! who can unconcern'dly find
 Hours, days and years slide soft away,
 In health of body, peace of mind,
 Quiet by day,

Sound sleep by night; study and ease
Together mix'd; sweet recreation;
And innocence, which most does please,
With meditation.

Thus let me live, unseen, unknown;
Thus unlamented let me die;
Steal from the world, and not a stone
Tell where I lie.

- *Alexander Pope*

B Answer the questions.

- 1 What things does a happy man have?
- 2 How does he pass his time?
- 3 How does he wish to die?
- 4 How do you think you can be happy in life?

Lesson 3: Hygiene

Key words : hygiene godliness achieve spiritually soul

A Read the questions first. Then read the text and answer them in short.

- 1 What can be a hotbed of germs?
- 2 How many times should we brush our teeth a day?
- 3 What kind of water should we drink?

The word 'hygiene' means the practice of keeping ourselves clean. It also means to keep our home and work places clean. It is important for our good health.

Hygiene is thought to be next to godliness. It is because we cannot achieve anything physically, mentally or spiritually if we are unclean in our body, mind and soul. Nobody likes an unclean person either. So we must follow the rules of hygiene.

First, we must keep our body clean. We should have a bath every day and wash our hair regularly. This will keep the body and hair free from dirt and bacteria.

Secondly, we should wash our clothes regularly. Dirty clothes give off bad smell and invite germs. We should wear socks and shoes when we go out to protect our feet from dust and germs. It is also important to wash our hands before meals and after using the toilet. We should brush our teeth twice a day, after breakfast and supper. We must also cut our nails regularly. Our drinking water must be safe. We can get safe water by boiling and filtering.

Finally, we should keep our surroundings and environment clean.

If we do and follow all the above things properly, we will be able to lead a healthy and happy life.

B Read the following statements and say if they are True or False. If False give the correct information.

- 1 Cleanliness is a part of good health.
- 2 Cleanliness is very important for mental health.
- 3 We need to wear socks and shoes to look smart.
- 4 We need to brush our teeth before meals.
- 5 We must keep ourselves clean.
- 6 We can have pure drinking water from tube wells.

C Complete the following sentences.

- 1 If we are healthy, we ----- .
- 2 We must be clean so that----- .
- 3 You must take exercise to ----- .
- 4 Nobody likes an ----- .
- 5 If we obey the laws of hygiene, we ----- .

D Work in groups. Make a list of five things that you do daily to maintain personal hygiene. Share with other groups, make a poster and display it to the class.

Lesson 4: A Dialogue

Key word : prescribe

A Talk about the picture and answer the questions.

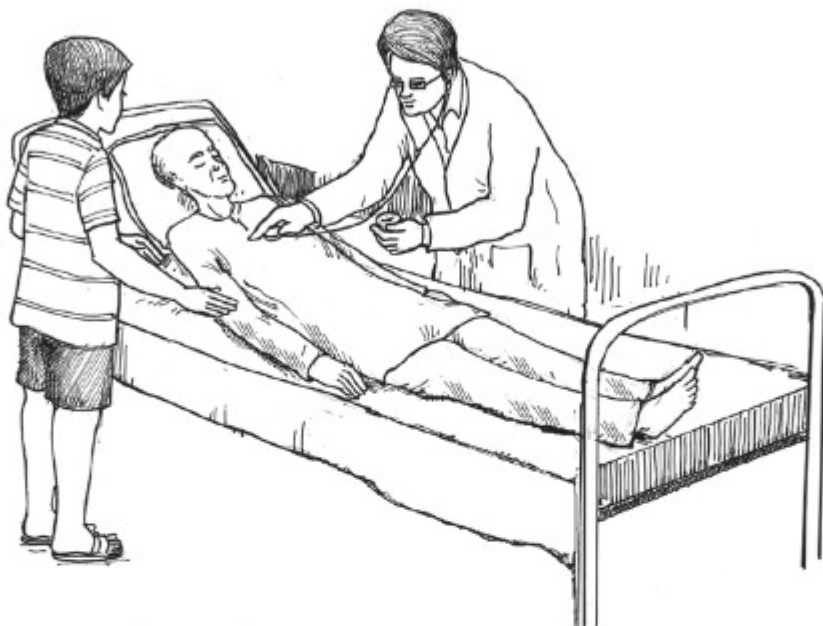

- 1 Who is the man lying on the examination table?
- 2 Who is examining the patient?

B Read and act out the conversation.

Rabi's father Mr Zahir Ali is not well. He has difficulty in speaking. He is now at the doctor's clinic.

Rabi : Good evening, doctor.

Doctor : Good evening. How is your father today?

Rabi : Not at all well. He has difficulty in breathing as before. He is having severe chest pain again.

Doctor : I see. Mr Ali, could you lie down on the examination table, please? OK, let's see... Do you feel any pain here?

Zahir : Ooh!

Doctor : And here?

Zahir : Ouch!

Doctor : All right. I'm prescribing a medicine. Take one tablet in the morning and another at night before meals. I also advise you to have a chest X-ray immediately. If possible show me the X-ray report today in the evening. OK?

Rabi : Okay, doctor. Thank you.

Doctor : You are welcome.

C Answer the following questions.

- 1 Who are talking in the dialogue?
- 2 Where does the dialogue take place?
- 3 What are Zahir Ali's problems?
- 4 Why can't Zahir Ali tell the doctor about his problems?
- 5 What does the doctor prescribe him?

D Ask and answer the questions in pairs.

- 1 Did you have any stomach pain or leg injury anytime before?
- 2 When was it?
- 3 What did you do to get well?

E Suppose you visited a doctor for a stomach pain or bad cold. Make an imaginary dialogue between you and the doctor. Act it out in pairs.

Lesson 5: A Letter

Key words : nicotine tragedy broke puff

A Read the letter silently to know what happened to Zahir Ali and tick the best answer.

10/E Purana Paltan

Dhaka 1000

9 June 2013

Dear Sohel

I am sorry I could not reply to your letter earlier. This is because last week there was a tragedy in our family. My father died of lung cancer.

He used to smoke heavily. He got the bad habit from his college days. Recently my mother and I were very worried about Father's worsening health condition. He was having continuous chest pain. The doctor showed him his chest X-ray plates. There were dark marks on his lungs. The doctor explained to him that the marks were the signs of lung cancer. He also explained that a poisonous substance called nicotine is in tobacco leaves; and cigarettes are made from tobacco leaves. When a person smokes cigarettes, this nicotine enters into his lungs with every puff. If anybody smokes cigarettes for years, this deadly nicotine causes lung cancer. Both mother and I tried to stop father from smoking. He never listened to our requests and warnings. He died an untimely death.

Let me tell you the truth. My father's death is a great shock for us. You know, we are a big family of seven. My father was the only earning member in the family. We are now broke and we don't know how we are going to survive.

Anyway, God is merciful and we are trying to recover from the shock. Write me when you have the time. Give my regards to your parents.

Love

Rabi

1 "My father's death is a great tragedy."

The underlined word means

- a very sad event.
- a very strong warning.
- smoking heavily.
- lung cancer.

2 Rabi's family is now completely broke because

- a his father had lung cancer.
- b they have now no source of income.
- c his father's death was heart breaking.
- d his father is a chain smoker.

B Ask and answer the question. First say, then write.

- 1 What could be the relationship between the sender and the receiver of the letter?
- 2 What causes lung cancer?
- 3 Who do you think are the members of Rabi's family? Why do you think so?

C Imagine you are Sohel. Now write a reply to Rabi's letter.

Lesson 6: Physical exercise

Key words : stretching benefit regularity

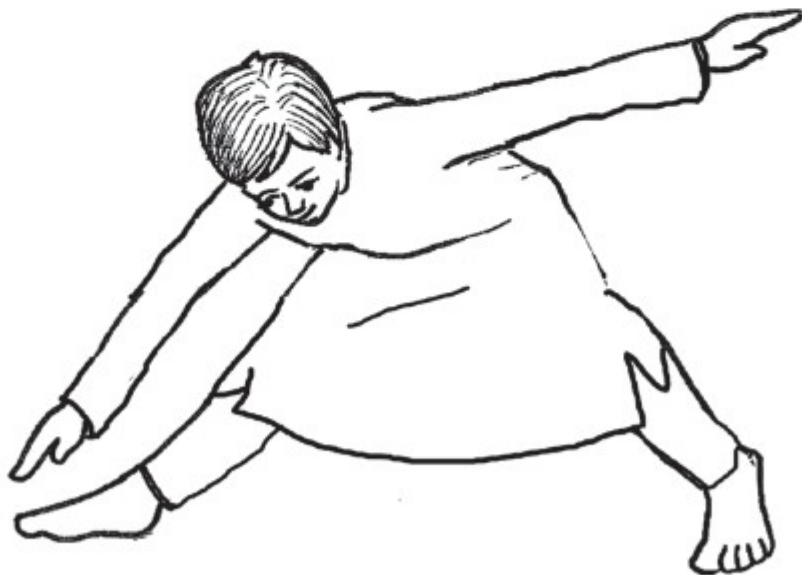
A Look at the picture and talk about it with your partner.**B Read the text and answer the following questions.**

Mr Asif Ahmed, the physical teacher of Rooppur Madrasah is talking about health to his students.

"What things are necessary for good health?" he asks the students.

"We need a lot of things, teacher," says Rashed. "We need healthy food, proper rest and sleep. We also have to be clean and tidy."

"Good!" says Mr Asif. "These are the things you need for good health. But another thing that you also need is regular physical exercise."

"What types of physical exercise can we do, teacher?" asks Rayeed.

"Well," says Mr Asif. "There are different kinds of physical exercise. You can do them indoors as well as outdoors. In the house you can do some freehand exercises. That is, you can stretch different parts of your body. Outside, you can play, swim or simply walk."

"Why do we need physical exercise, teacher?" asks Rahim.

"Well", says Mr Asif, "The benefits of physical exercise are many. The greatest of them is that it keeps you fit for work. It also gives you energy, and makes you strong and cheerful. It teaches you regularity and discipline as well."

Questions

- 1 What things are necessary for good health?
- 2 How many physical exercises are there?
- 3 Why do we need physical exercise?
- 4 What physical exercises do you do?
- 5 Do you have a physical education teacher in your Madrasah? How does s/he help you to do physical exercise?

- C Here is a list of some physical exercises. Write in your notebook which one are indoor exercises and which are outdoor, and which one can be done both indoors and outdoors. Finally, tick which one/ones you like. Then tell the class the reason/s for your liking.**

List of exercises

- 1 playing sports
- 2 swimming
- 3 skipping
- 4 jogging
- 5 walking
- 6 stretching

D Ask and answer the questions.

- 1 Do you do physical exercise every day? What sort of exercise do you do?
- 2 Why do you need regular physical exercise?
- 3 What does physical exercise teach you?
- 4 What's your favourite sport? Do you take part in it? If so, where do you play it and who with?

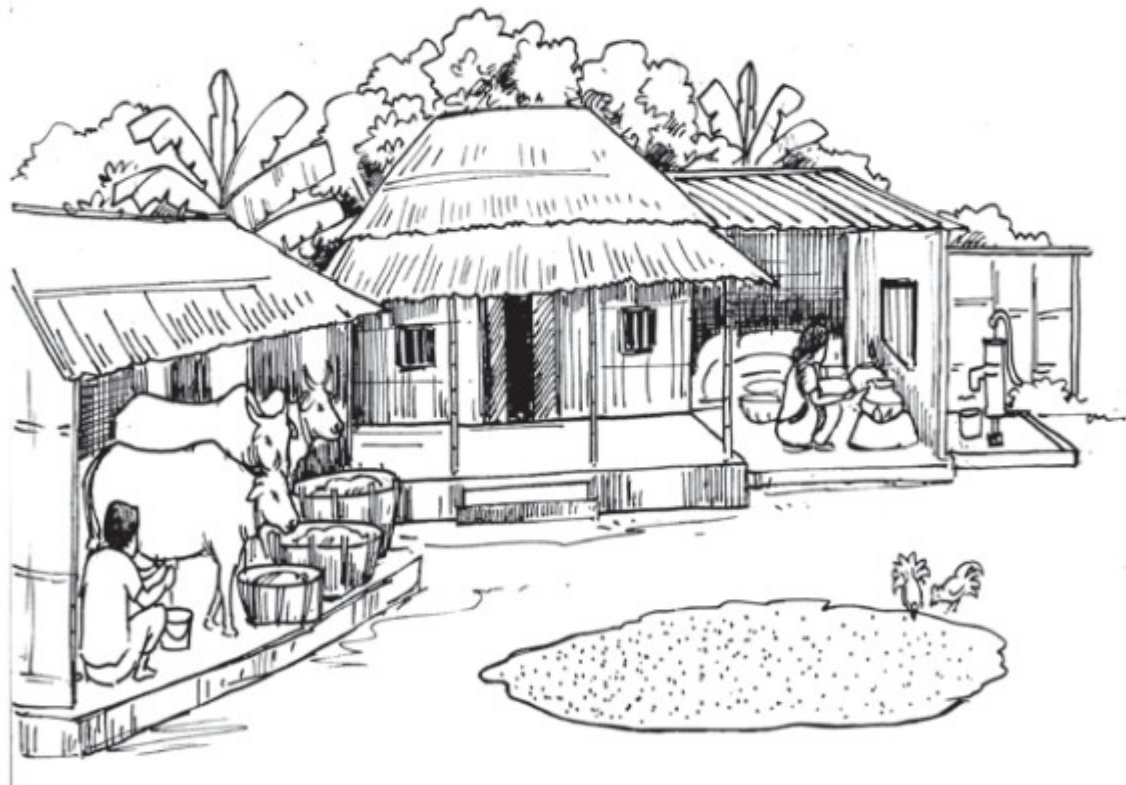
Lesson 7: A Healthy and Happy Family**A Look at the picture. Then ask and answer the questions about it.****Questions**

- 1 What do you see in the picture?
- 2 How do you feel living in such a house?
- 3 Where can you find this type of house? Why do you think so?

B Listen to the teacher/CD and answer the following questions.

U3, L7 B
Listening text: 2

- 1 How far is Shakib's house from his school?
- 2 Why is Shakib's house free from mosquitoes?

C Listen again and write 'True' or 'False' against each of the following statements.

- 1 Shakib's family lives in a remote town.
- 2 He has no brothers or sisters.
- 3 His parents do not know how to read or write.
- 4 His mother is an excellent cook.
- 5 Shakib does not participate in cleaning activities at home.

D Look at the table, then listen again to the teacher/CD. The table has some words from the text that you have just listened. First guess the meanings of the words. Then match them with their meanings. One is done for you.

Words	Meanings
remote	knowing about something
literate	about a disease that spreads from one person to another
delicious	isolated
aware	that causes harm to your health
harmful	having a very pleasant taste
contagious	able to read or write.

Lesson 8: Making a Class Committee

Key words : forum environment fortnightly

A Look at the two pictures. Then ask and answer questions.



Picture 1



Picture 2

- 1 What do you see in the picture ?
- 2 What are the students doing in picture 1 & 2?
- 3 Do you do these things at home? If you don't, who does ?

B Read the passage and answer the following questions.

Ms Rehana Sultana, the class teacher, has just entered the classroom. She is now talking to the students.

"Why is the classroom so dirty?" asks Ms Sultana. "I know the Madrasah cleaner is absent today. So what? Can't we ourselves keep our classroom clean?" says Ms Saha. "Sorry teacher," Shafiq, the class captain, says politely. "This is our classroom. If you clean it, you will do physical work and feel good. Also it is our responsibility to keep it clean and tidy", says Ms Sultana.

"Okay, teacher," says Shafiq, "We'll do it from now on."

"First, you can make a forum, and select a leader," the class teacher suggests. "Then divide the cleaning activities among different groups."

"It's really a great idea, teacher," says Shafiq. "We'll make the committee now and start working immediately."

After this, a committee is formed by class 8 students under the leadership of their class captain. The students are divided into several groups and a work plan is made for cleaning. The students decided to make some ground rules. Here is a list of some of the rules:

- Do not spit in the classroom.
- Do not drop litter in the classroom.
- Use the bin for trash.
- Keep the desks and chairs in place.

All the students of class 8 are very excited to be involved in this activity at school.

C Choose the best answer.

- 1 Ms Rehana Sultana is
 - a a physical education teacher.
 - b an English teacher.
 - c a class teacher.
 - d a science teacher.
- 2 The class teacher suggested the students to make a forum
 - a to keep their classroom clean.
 - b to participate in social activities.
 - c to keep the Madrasah environment clean.
 - d to help each other.
- 3 The students were happy to be able to
 - a become the members of the committee.
 - b take part in the cleaning programme at Madrasah.
 - c make their class captain leader of the committee.
 - d make themselves good students.

Unit Four

Check Your Reference

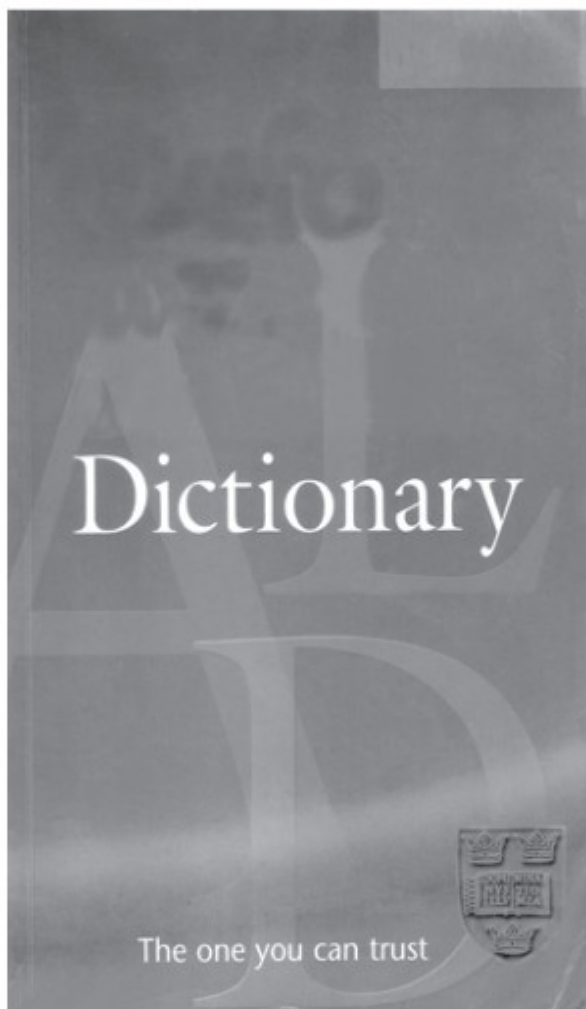



After we have studied this unit, we will be able to

- read and understand content pages in books
- look up words in a dictionary

Lesson 1: Introducing a Table of Contents

A Look at the table and talk about it in groups.

Contents

	To the Instructor	vii
	To the Student	xiii
	Acknowledgments	xv
	Unit 1 <i>Animals</i>	
	1. The Kiwi	3
	2. The Camel	6
	3. The Polar Bear	11
	4. The Hippopotamus	16
	5. The Dolphin	21
	Word Study	26
	Extension Activities	29
	• GW. Video Activity: Dolphins in Honduras	29
	• Activity Page	31
	• Dictionary Page	32
	Unit 2 <i>How? Why?</i>	
	Context Clues	34
	1. Why Are Elevators Important?	36
	2. Why Is the Sea Salty?	41
	3. How Can a Plant Kill?	46
	4. How Can We Have Farms in the Sea?	52
	5. How Do Hearing-Impaired People Talk?	57
	Word Study	62
	Extension Activities	65
	• GW. Video Activity: A New Kind of Tourism in Brazil	65
	• Activity Page	67
	• Dictionary Page	68
	Unit 3 <i>Plants</i>	
	Context Clues	70
	1. The Date Palm	72
	2. The Water Hyacinth	77
	3. Rice	82
	4. Oranges	87

B Now, answer the questions below.

- 1 Is the table familiar to you?
- 2 Where do you find it?
- 3 What is the table about?
- 4 What is this table called?

C Read the text and discuss it in groups. Then find answers to the following questions.

You get a new book in hand. You see the title of the book and you want to read it. But does the title only give you enough information about what the book is all about?

You also find the book divided into a few parts. Suppose you want to read a certain part of the book. Certainly you will not like to waste time looking for it in the whole book.

- 1 How do you know which page to look for it? What do you do?
- 2 Do you think the table in A can help you? How?

D Look at the table of contents in Section A. Then ask and answer the questions below.

- 1 What are the topics at page numbers vii, xiii, xv ?
- 2 If you want to read about the Hippopotamus, what unit and page numbers should you go to ?
- 3 What is the content at page number 65 ?
- 4 What page does the unit 2 start at and where does it end ?
- 5 Which topics appear between pages 26 –28?

E Open the table of contents page of your English Textbook. Work in pairs and find out the answers to the following questions.

- 1 What is the title of the page?
- 2 What are the column heads?
- 3 Which page numbers contain the topics?
- 4 Which topic starts in page 44?
- 5 How many units are there?
- 6 How many page numbers are there in the book?

F Now, give information about the following.

Name/title of the table of contents page:

Names of column heads:

Numbers of units:

Total number of pages:

Title of the first unit:

Page number where the first unit starts:

Title of the last unit:

Position of the page numbers:

Position of the chapter titles:

Others, if any:

Lesson 2: Using a dictionary

A Look at the questions and the text and talk about them in groups.

- 1 Have you come across this type of text before?
- 2 Do you know what the text is about?
- 3 What do you know about a dictionary?
- 4 What do you find in a dictionary?

fit *fit* /fit/ verb, adj., noun

■ **verb** (fit-ting, fit-ted, fit-ted) (NAME usually fit-ting, fit, fit except in the passive)

• **RIGHT SIZE/TYPE 1** (not used in the progressive tenses) to be the right shape and size for sb/sth: [V] *I tried the dress on but it didn't fit.* ◊ *That jacket fits well.* ◊ *a close-fitting dress* ◊ [VN] *I can't find clothes to fit me.* ◊ *The key doesn't fit the lock.* **2** [V, usually + *adv./prep.*] to be of the right size, type or number to go somewhere: *I'd like to have a desk in the room but it won't fit.* ◊ *All the kids will fit in the back of the car.* **3** [VN] [often passive] ~ sb (for sth) to put clothes on sb and make them the right size and shape:

• **PUT STH SOMEWHERE 4** [VN] to put or fix sth some-
They fitted a smoke alarm to the ceiling. ◊ *The rooms were all fitted with smoke alarms.* **5** [+*adv./prep.*] to put or join sth in the right place: [V] *The glass fits on top of the jug to form a lid.* ◊ *How do these two parts fit together?* ◊ [VN] *We fitted together the pieces of the puzzle.*

• **AGREE/MATCH 6** (not used in the progressive tenses) to agree with, match or be suitable for sth; to make sth do this: [V] *Something doesn't quite fit here.* ◊ *His pictures don't fit into any category.* ◊ [VN] *The facts certainly fit your theory.* ◊ *The punishment ought to fit the crime.* ◊ *We should fit the punishment to the crime.*

• **MAKE SUITABLE 7** ~ sb/sth (for sth) (especially BrE) to make sb/sth suitable for a particular job: [VN, VN to inf] *His experience fitted him perfectly for the job.* ◊ *His experience fitted him to do the job.*

■ **adj.** (fitter, fittest)

• **HEALTHY 1** ~ (for sth) | ~ (to do sth) healthy and strong, especially because you do regular physical exercise: *Top athletes have to be very fit.* ◊ (BrE) *He won't be fit to play in the match on Saturday.* ◊ *She tries to keep fit by jogging every day.* ◊ (BrE) *He's had a bad cold and isn't fit enough for work yet.* ◊ *I feel really fighting fit* (= very healthy and full of energy). ◊ *The government aims to make British industry leaner and fitter* (= employing fewer people and with lower costs).—see also KEEP-FIT **OPP** UNFIT ⇨ note at WELL ⇨ vocabulary notes on page R18

• **SUITABLE 2** ~ for sb/sth | ~ to do sth suitable; of the right quality; with the right qualities or skills: *The food was not fit for human consumption.* ◊ *It was a meal fit for a king* (= of very good quality). ◊ *Your car isn't fit to be on the road!* ◊ *The children seem to think I'm only fit for cooking and washing!* ◊ *He's so angry he's in no fit state to see anyone.* ◊ (formal) *This is not a fit place for you to live.* **OPP** UNFIT

• **READY 3** ~ to do sth (BrE, informal) ready or likely to do sth extreme: *They worked until they were fit to drop* (= so tired that they were likely to fall down). ◊ *I've eaten so much I'm fit to burst.* ◊ *She was laughing fit to burst* (= very much).

IDM (as) fit as a fiddle (informal) in very good physical condition see/think 'fit (to do sth)' (formal) to consider it right or acceptable to do sth; to decide or choose to do sth: *You must do as you think fit* (= but I don't agree with your decision). ◊ *The newspaper did not see fit to publish my letter* (= and I criticize it for that).—more at SURVIVAL

■ **noun**

• **ILLNESS 1** [C] a sudden attack of an illness, such as EPILEPSY, in which sb becomes unconscious and their body may make violent movements **SYN** CONVULSION: *to have an epileptic fit* ◊ *Her fits are now controlled by drugs.*

• **OF COUGHING/LAUGHTER 2** [C] a sudden short period of coughing or of laughing, that you cannot control **SYN** BOUT: *a fit of coughing* ◊ *He had us all in fits (of laughter) with his jokes.*

• **OF STRONG FEELING 3** [C] a short period of very strong feeling: *to act in a fit of anger/rage/temper/plique*—see also HISSY FIT

• **OF CLOTHING 4** [C,U] (often with an adjective) the way that sth, especially a piece of clothing, fits: *a good/bad/close/perfect fit*

• **MATCH 5** [C] ~ (between A and B) the way that two things match each other or are suitable for each other: *We need to work out the best fit between the staff required and the staff available.*

IDM by/in fits and starts frequently starting and stopping again; not continuously: *Because of other commitments I can only write my book in fits and starts.* have/throw a fit (informal) to be very shocked, upset or angry: *Your mother would have a fit if she knew you'd been drinking!*

fit-ful /'fitfʊl/ adj. happening only for short periods; not continuous or regular: *a fitful night's sleep* ▶ **fit-fully** /'fitfʊli/ adv.: *to sleep fitfully*

fit-ment /'fitmənt/ noun [usually pl.] (BrE, technical) a piece of furniture or equipment, especially one that is made for and fixed in a particular place

fit-ness /'fitnəs/ noun [U] **1** the state of being physically healthy and strong: *a magazine on health and fitness* ◊ *a fitness instructor/class/test* ◊ *a high level of physical fitness* **2** ~ for sth/to do sth the state of being suitable or good enough for sth: *He convinced us of his fitness for the task.* ◊ *There were doubts about her fitness to hold office.*

fitness centre (BrE) (NAME 'fitness center') noun a place where people go to do physical exercise in order to stay or become healthy and fit

fit-ted /'fittɪd/ adj. **1** [only before noun] (especially BrE) (of furniture) built to be fixed into a particular space **SYN** BUILT-IN: *fitted wardrobes/cupboards* **2** [only before noun] (especially BrE) (of a room) with matching cupboards and other furniture built for the space and fixed in place: *a fitted kitchen/bedroom* **3** [only before noun] (of clothes) made to follow the shape of the body: *a fitted jacket* **OPP** LOOSE **4** ~ for/to sth | ~ to do sth (especially BrE) suitable; with the right qualities and skills: *She was well fitted to the role of tragic heroine.* **5** ~ with sth having sth as equipment: *Insurance costs will be reduced for houses fitted with window locks.*

fitted carpet noun (BrE) a carpet that is cut and fixed to cover the floor of a room completely—see also WALL-TO-WALL CARPET

fit-ter /'fɪtə(r)/ noun **1** a person whose job is to put together or repair equipment: *a gas fitter* **2** a person whose job is to cut and fit clothes or carpets, etc.

fit-ting /'fɪtɪŋ/ adj., noun

■ **adj.** **1** (formal) suitable or right for the occasion **SYN** APPROPRIATE: *The award was a fitting tribute to her years of devoted work.*

◊ *It is fitting that the new centre for European studies should be in a university that teaches every European language.* **2** -fitting (in adjectives) having a particular FIT:

■ **noun 1** [usually pl.] a small part on a piece of equipment or furniture: *light fittings* ◊ *a pine cupboard with brass fittings* **2** [usually pl.] (BrE) items in a house such as a cooker, lights or shelves that are usually fixed but that you can take with you when you move to a new house—compare FIXTURE **3** an occasion when you try on a piece of clothing that is being made for you to see if it fits

B Look at the dictionary page in Lesson 3 and answer the following questions. Then read the text below.

Do you use a dictionary?

Why and how often do you use a dictionary?

How can a dictionary help you?

A dictionary is a collection of words. It lists the words of a language and gives necessary information about them. It tells us about the

- a) spelling
- b) pronunciation
- c) meaning
- d) word class

To make the meanings of words clear, example sentences are given in *italics*. Example sentences show how words are used. It also gives the synonym/s and the antonym/s of a word.

We find words made by adding prefixes and suffixes to the root word. Parts of speech are also shown. A verb word is always given in the simple present tense. But the past form of a verb and the past participle are also shown.

C Again read the text above. Then ask and answer the following questions.

- 1 What information does a dictionary give us about a verb word?
- 2 Why are the example sentences given?
- 3 How are new words formed?
- 4 Why are the synonyms and the antonyms given?
- 5 What do we need a dictionary for?

D Match the sentence parts in Column A with those in Column B.

Column A	Column B
A dictionary shows	in its simple present tense.
Prefixes and suffixes	about the words of a language.
A verb word is always given	help to make new words.
Meanings of words are given	how to pronounce a word.
A dictionary gives information	in a dictionary.

Lesson 3: Looking Up Words in a Dictionary

A Talk in groups about the text in Lesson 4 and about the questions below. Then read the text.

- 1 Is there any connection between the alphabet and a dictionary?
- 2 What do you understand by alphabetical order?

The words in a dictionary are presented in alphabetical order. It follows the alphabetical order of letters. It means words starting with the letter D will be before the words starting with the letter E. In the same way words starting with the letter F will come after the words starting with E.

Again the words starting with the same letter are also arranged one after another in alphabetical order in the dictionary. For example, the words 'dark', 'doctor' and 'deep' all start with the letter D. These words appear in the dictionary in the order of *dark*, *deep* and *doctor*.

To find the words with a letter, look at the words at the top of the page.

While doing the activities, use a dictionary or a dictionary page as much as you can.

B Arrange the following words in alphabetical order.

entertainment, knowledge, culture, art, painting, thought, interest, heritage, yellow, future.

C Work in pairs. Arrange the following words under the letter 'S' in alphabetical order as they appear in the dictionary.

single	should	system	sufficient
solar	source	steel	sweet

D Find and write the words coming between the words 'tea' and 'technique' under the letter 't' in your dictionary.

E Show in which order are the following words arranged in Lesson 3.

fit fitted fitful fitness fitting fitter fitment

Lesson 4: Meanings of Words

A Look at the questions below and read the following text. Now discuss in pairs.

- 1 What do you do when you want to know the meaning of a word?
- 2 How can a dictionary help us?

A dictionary gives us the meaning/meanings of a word. Example sentences are given to show how the words are used. They also help to make the meaning clear. A word may have more than one meaning.

The word 'dry' (adj) has a number of meanings. Three of them are given here.

- (i) not wet, not damp, not sticky: *The river becomes dry during the summer.*
- (ii) with very little rain: *I hope the weather remains dry during our picnic.*
- (iii) not interesting: *His speech was quite dry.*

Sometimes the synonyms and antonyms given with words help to understand the meanings of words.

B Find at least two meanings for each of the following words from the dictionary page in Lesson 3. Do the activities in pairs. Use a dictionary.

fit fitness fitter fitting fitted

Now, make your own example sentences using the two meaning of each word.

Lesson 5: Synonyms and Antonyms

A Look at the questions. Ask and answer.

- What is a synonym ?
- What is an antonym ?
- Do you know of any two words with the same or nearly the same meaning ?
- What about 'boring' and 'dull' ?
- Do you know a word that means just the opposite of another word ?
- What about 'obey' and 'disobey' ?

B Read the text and do the following activities in pairs.

A synonym is a word that means the same or almost the same as another word. There may be more than one synonym for some of the words. Big and large, 'begin' and 'start' are synonyms.

An antonym is a word that means the opposite of another word. 'Sorrow' and 'happiness', 'right' and 'wrong' are examples of antonyms.

C Find the synonyms of the following words. Take help of the dictionary.

idle text annoyed result goal trip valuable return

D Find the synonyms of the words in the dictionary page in Lesson 3.

fit fitted fitting

Make sentences with the synonyms.

E Find the antonyms of the words in the dictionary page in Lesson 3.

fit fitted

Make sentences with the antonyms.

F From your dictionary find the antonyms of the following words.

profit complete strong hard different sweet fair minor

G Match a word in A with a synonym in B.

A	B
noise	harm
boring	sight
handy	irritate
mend	dull
damage	useful
jealous	row
annoy	envious
view	fix

H Fill in the boxes with the synonyms of the word 'happy'.

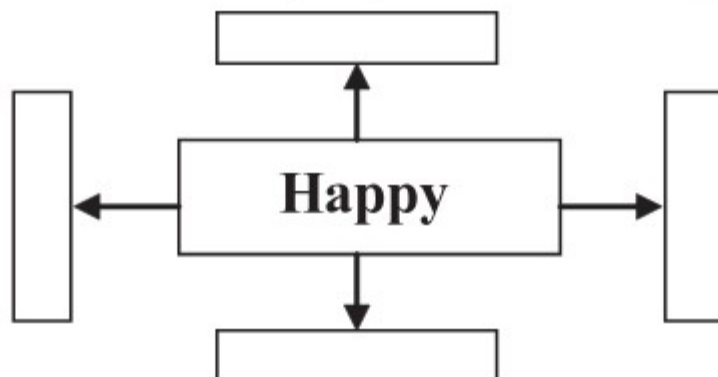

I Match a word in A with its opposite in B.

A	B
high	accept
lose	light
refuse	low
temporary	subtract
heavy	permanent
add	gain
minor	outdoor
indoor	major

J Fill in the boxes with the opposites/ antonyms of the word 'happy'.

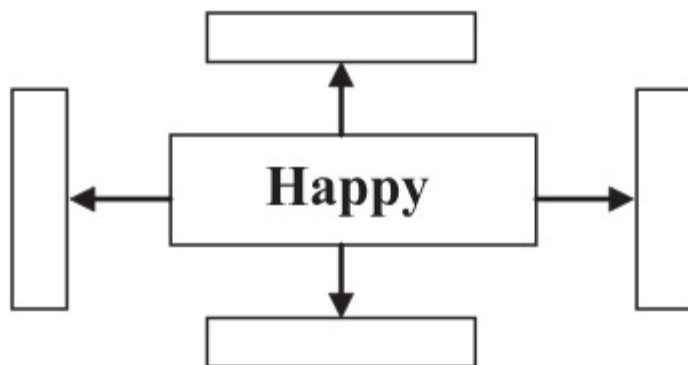

Unit Five

Humans and Environment

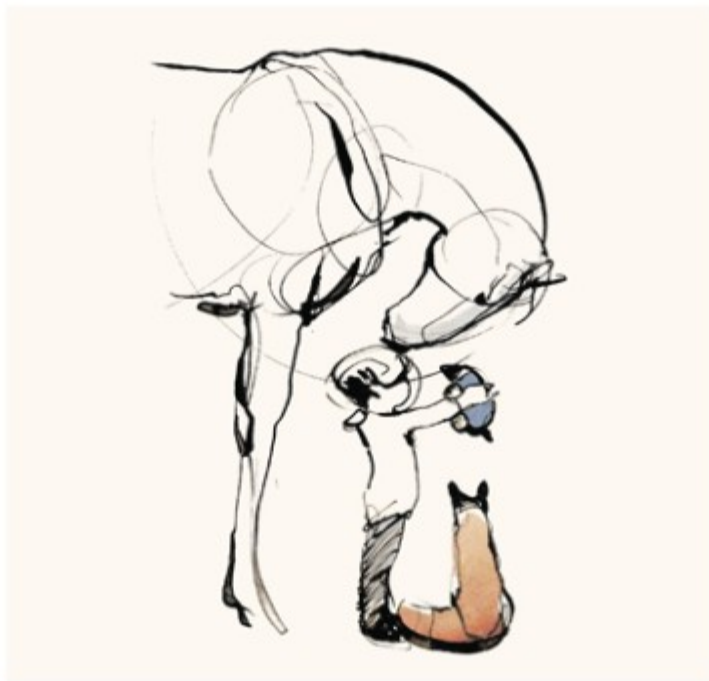

Sketch: Charlie Mackesy

After we have studied the unit, we will be able to

- understand the relationship between human beings and nature
- sympathise with the different species living on planet earth
- read and understand texts
- ask and answer questions
- write the main ideas in our own words



Lesson 1: The Little Bird

Key phrases: bird-catching net, gasping for breath, it was dead, caged bird, let it go, picture books

A. Look at the sketch and discuss with your classmates what you see in it.



B. Read the story by Leo Tolstoy and answer the questions that follow:

It was Seryozha's birthday, and he received many presents: tops, hobby-horses and picture books. But the best gift of all was from his uncle. It was a net for catching birds.

A little board was attached to a frame on which a net was stretched. Grain was sprinkled on the board, and then the net was set out in the yard. When a bird flew up and perched on the board, the board would turn over and the net would fall.

Seryozha was so happy he came running to his mother to show her his net.

His mother said, "It's not a nice toy at all. What do you want with little birds? Why do you want to torment them?"

"I'll put them in cages. They'll sing, and I'll feed them." Seryozha got some grain, sprinkled it on the little board and set the net out in the garden. He stood next to it, waiting for birds to come flying down. But the birds were afraid of him and did not come near the net.

Seryozha went in to dinner and left the net in the garden.

When he came to look at it after dinner he saw that the net had fallen and a little bird was thrashing about under it. Seryozha was very excited. He caught the bird and took it into the house.

“Look, Mamma! I’ve caught a bird. It must be a nightingale. Oh, how fast its heart is beating.”

His mother said, “It’s a siskin. Don’t torment it. Let it go.”

“No, I’ll feed it and care for it.”

Seryozha put the siskin in a cage, and for two days he fed it grain, changed its water and cleaned the cage. On the third day he forgot about the siskin and did not change its water.

Then his mother said to him, “See? You forgot all about your little bird. I think you had better let it go.”

No, I won’t forget. I’ll give it some fresh water now and clean the cage.”

Seryozha stuck his hand into the cage and began cleaning it, but the siskin became frightened and beat its wings against the cage. Seryozha cleaned the cage out and went for water.

His mother saw that he had forgotten to close the little door and called after him, “Close the cage door, Seryozha, or your bird might fly out and hurt itself.”

No sooner had she said this than the siskin found the door, spread its wings happily and flew across the room to the window. But it did not see the glass pane. It hit the pane and fell to the windowsill.

Seryozha came running, picked up the little bird and took it back to the cage. The siskin was alive, but it lay on its breast with its little wings spread out and was breathing jerkily.

Seryozha began to cry.

“Mamma! What’ll I do?”

“There’s nothing you can do now.”

Seryozha did not leave the room that day. He kept gazing at the siskin. The siskin lay on its breast as before, breathing jerkily.

When Seryozha went to bed that night the siskin was still alive.

Seryozha could not fall asleep for a long while. No sooner would he close his eyes than he would imagine the siskin lying there, gasping for breath.

When Seryozha went up to the cage the next morning he saw the siskin lying on its back with its legs curled up. It was dead.
Never again did Seryozha catch another bird.

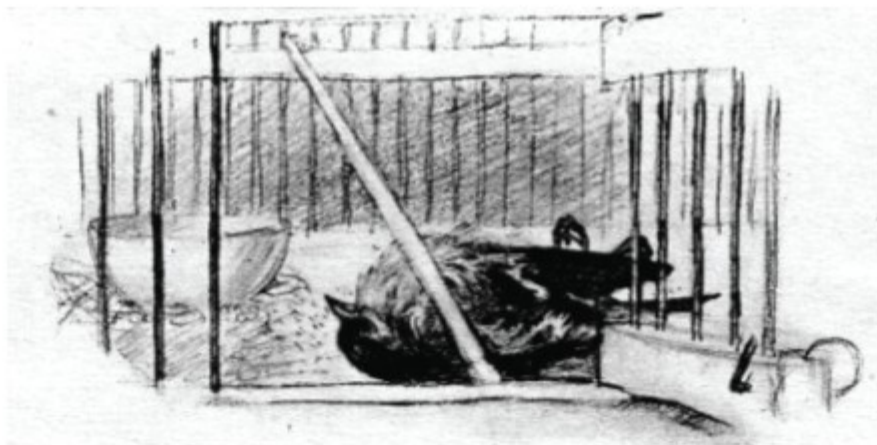

C. Match the words in Column A with their meanings in Column

Column A (Difficult Words)	Column B (Meanings)
1. Nightingale	A. A ledge below a window
2. Siskin	B. Breathing with difficulty
3. Thrashing	C. To cause distress or suffering
4. Torment	D. A small bird known for its song
5. Perched	E. Moving violently or wildly
6. Jerkily	F. A sheet of glass in a window
7. Pane	G. A small songbird related to finches
8. Windowsill	H. Sitting or resting on something high
9. Gasping	I. Moving in sudden, sharp motions

D. True or false? If false, write the correct statement.

- Seryozha's mother was happy with the bird-catching net.
- Seryozha caught a siskin using the net.
- Seryozha forgot to feed the bird on the second day.
- The siskin flew into the window after escaping from the cage.
- Seryozha's mother helped him catch the bird.
- Seryozha never tried to catch another bird after the siskin died.

E. Answer the following questions:

1. What did Seryozha receive as a gift from his uncle?
2. Why did Seryozha's mother not like the idea of catching birds?
3. What kind of bird did Seryozha catch in the net?
4. How did Seryozha take care of the bird at first?
5. If you were in Seryozha's place, what would you have done differently after catching the siskin?

F. Make a list of birds in your locality and categorise which are wild and which are domestic?**Lesson 2: Poems about Nature****A. Look at the image and discuss in groups the possible answers to the questions:**

1. What could be the colours of the field, the trees and birds?
2. Where are the birds going?

B. Now read the poem by Rachel Field and answer the questions that follow:

Something Told the Wild Geese

Something told the wild geese
It was time to go.
Though the fields lay golden
Something whispered, — "snow".

Leaves were green and stirring,
Berries, lustre-glossed,
But beneath warm feathers
Something cautioned, — "frost".

All the sagging orchards
Steamed with amber spice,
But each wild breast stiffened
At remembered ice.

Something told the wild geese
It was time to fly —
Summer sun was on their wings,
Winter in their cry.

Note

Lustre-glossed – Shiny and smooth.

Cautioned – Gave a warning.

Sagging – Hanging down or sinking.

Amber – A warm, yellow-brown colour.

Stiffened – Became hard or tense.

Steamed – Gave off steam or mist.

C. Answer the following questions:

1. What makes the geese decide to leave?
2. What happens to the leaves and berries in the poem?
3. What changes in nature tell us that winter is near?

D. Read another poem on nature**Green Escape**

--Joseph Auslander

I have turned my face
Away from streets and crowds
To a windy place
And clouds.

I have turned from skyscrapers
That scratch out the sky,
From wet newspapers
Always whipping by.

I have taken away my heart,
I will give it again
To be split apart
By wind and rain.

I will stand like a stone
All day in the grass
Where the bees drone
And pass and repass.

I will watch them brush
Gold across their legs,
Hear the bird at hush
Over her eggs.

I will hear the wild swan
Lift high and harsh
His crooked clarion
Across the marsh.

Where the jewel-weed hangs,
Where the spotted stream runs,
Where the green beetle bangs
Bronze on bronze—

Rooted in the deep ground,
The sky tugging at my hair,
There will I be found—
There!

Note

Skyscrapers – Very tall buildings.

Whipping – Moving quickly or being blown around by the wind.

Drone – A continuous, low humming sound, like bees make.

Repass – To pass by again.

Clarion – A loud, clear sound, like a trumpet.

Marsh – Wet, grassy land, often near water.

Jewel-weed – A type of plant with bright orange or yellow flowers.

Rooted – Fixed firmly in place, like a plant in the ground.

Tugging – Pulling something with effort.

C. Answer the following questions:

1. Why does the speaker turn away from the streets and crowds?
2. What does the speaker hear and see in the grass?
3. How does the speaker describe the sound of the swan?
4. Where does the speaker want to be found at the end of the poem?

Lesson 3: Dancing Bears**A. Read the story by Spencer Holst and answer the following questions:****Brilliant Silence**

Two Alaskan Kodiak bears joined a small circus where the pair appeared in a nightly parade pulling a covered wagon. The two were taught to somersault, to spin, to stand on their heads, and to dance on their hind legs, paw in paw, stepping in unison. Under a spotlight the dancing bears, a male and a female, soon became favourites of the crowd. The circus went south on a West Coast tour through Canada to California and on down into Mexico, through Panama into South America,



down the Andes the length of Chile to those southernmost isles of Tierra del Fuego. There a jaguar jumped a juggler, and afterwards, mortally mauled the animal trainer; and the shocked show people disbanded in dismay and horror. In the confusion the bears went their own way. Without a master, they wandered off

by themselves into the wilderness on those densely wooded, wildly windy, subantarctic islands. Utterly away from people, on an out-of-the-way uninhabited island, and in a climate they found ideal, the bears mated, thrived, multiplied, and after a number of generations populated the entire island. Indeed, after some years, descendants of the two moved out onto half a dozen adjacent islands; and seventy years later, when scientists finally found and enthusiastically studied the bears, it was discovered that all of them, to a bear, were performing splendid circus tricks.

On nights when the sky is bright and the moon is full, they gather to dance. They gather the cubs and the juveniles in a circle around them. They gather out of the wind at the center of a sparkling, circular crater left by a meteorite which had fallen in a bed of chalk. Its glassy walls are chalk white, its flat floor is covered with white gravel, and it is well-drained, and dry. No vegetation grows within. When the moon rises above it, the light reflecting off the walls fills the crater with a pool of moonlight, so that it is twice as bright on the crater floor as anywhere else in that vicinity. Scientists speculate that originally the full moon had reminded the two bears of the circus spotlight, and for that reason they danced. Yet, it might be asked, what music do the descendants dance to? Paw in paw, stepping in unison what music can they possibly hear inside their heads as they dance under the full moon and the Aurora Australis, as they dance in brilliant silence?

Note

Kodiak: A type of bear that comes from Kodiak Island in Alaska.

Somersault: A movement where someone or something rolls over completely in the air or on the ground.

Unison: Doing something at the same time as others.

Jaguar: A large wild cat found mainly in South America.

Mauled: Attacked and injured badly by a person or animal

Subantarctic: Areas close to but just north of Antarctica

Adjacent: Next to or very close to something..

Speculate: To guess or make an assumption about something.

Aurora Australis: A natural light display in the sky near the South Pole.

Meteorite: A piece of rock or metal from space that lands on Earth.

Crater: A bowl-shaped hole in the ground caused by something like a meteorite.

Vicinity: The area around a particular place.

C. Complete the sentences with clues given:

Aurora Australis, travelled, remote, trained, mated, shiny, attacked, deep hollow, shock, pool.

- a) The bears were _____ to perform circus tricks.
- b) The circus _____ south on a West Coast tour.
- c) A jaguar _____ a juggler.
- d) The showpeople disbanded in _____.
- e) The bears wandered off into the _____ islands.
- f) They _____ and multiplied on the island.
- g) The meteorite left a _____ on the island.
- h) The bears danced in a _____ crater.
- i) The light from the moon filled the crater with a _____ of moonlight.
- j) They danced under the moon and the _____.

D. Choose the best answer.

1. What was the primary attraction of the two Kodiak bears in the circus?
 - a) Their ability to speak
 - b) Their size and strength
 - c) Their dancing and circus tricks
 - d) Their hunting skills
2. Where did the circus travel after leaving Canada?
 - a) Europe
 - b) South America
 - c) Alaska
 - d) Asia
3. What happened to the circus after the jaguar attacked?
 - a) The circus became more popular
 - b) The showpeople disbanded in fear
 - c) The bears were rescued by locals
 - d) The animal trainer survived and continued
4. After being separated from the circus, where did the bears wander?
 - a) Into a nearby town
 - b) Into the rainforest
 - c) Into subantarctic islands
 - d) Into the circus tent
5. Why did the bears thrive on the uninhabited island?
 - a) They were provided food by local people
 - b) They found an ideal climate and environment
 - c) They returned to the circus regularly
 - d) They learned to fish from local animals

- 6. How long after the circus incident did scientists discover the bears again?**
- a) 20 years b) 50 years
c) 70 years d) 100 years
- 7. What unusual discovery did scientists make about the descendants of the original bears?**
- a) They had become smaller in size
b) They performed circus tricks naturally
c) They had developed new hunting techniques
d) They had become nocturnal
- 8. Where do the bears gather to dance on nights with a full moon?**
- a) On the shore by the ocean b) In the forest near their dens
c) In a crater left by a meteorite d) On a mountain peak
- 9. What feature makes the crater where the bears dance unique?**
- a) It is covered with trees and flowers b) Its walls are chalk white and reflective
c) It is filled with water and fish d) It is surrounded by glaciers
- 10. What do scientists speculate reminds the bears of their circus days?**
- a) The sound of the wind
b) The presence of other animals
c) The full moon, which resembles the spotlight
d) The shape of the island

Lesson 4: The Farming Teacher

A. Talk about the picture and answer the questions:



- 1) What do you see in the picture?
- 2) Do you think that the children are enjoying what they are doing? Tell why.
- 3) Do you think it is important to learn how to farm? Explain.

B. Read the text by Tetsuko Kuroyanagi and answer the following questions

“This is your teacher today. He's going to show you all sorts of things.” With that the headmaster introduced a new teacher. Totto-chan took a good look at him. In the first place, he wasn't dressed like a teacher at all. He wore a short striped cotton work jacket over his undershirt, and instead of a necktie, he had a towel hanging around his neck. As for his trousers, they were of indigo-dyed cotton with narrow legs, and were full of patches. Instead of shoes, he wore workmen's thick two-toed, rubber-soled socks, while on his head was a rather dilapidated straw hat.

The children were all assembled by the pond at Kuhonbutsu Temple.

As she stared at the teacher, Totto-chan thought she had seen him before. “Where!” she wondered. His kindly face was sun burnt and full of wrinkles. Even the slender pipe dangling from a black cord around his waist that served as a belt looked familiar. She suddenly remembered!

“Aren't you the farmer who works in the field by the stream!” she asked him, delighted.

“That's right,” said the “teacher, with a toothy smile, wrinkling up his face. “You pass my place ev'ry time you go fer yer walks to Kuhonbutsu! That's my field. That one over there full o' mustard blossoms.”

“Wow! So you're going to be our teacher today, cried the children excitedly.

“Naw!” said the man, waving his hand in front of his face. “I ain't no teacher! I'm just a farmer. Your headmaster just asked me to do it, that's all.”

“Oh yes, he is. He's your farming teacher,” said the headmaster, standing beside him. “He very kindly agreed to teach you how to plant a field. It's like having a baker teach you how to make bread. Now then,” he said to the farmer, “tell the children what to do, and let's get started.”

At an ordinary elementary school, anyone who taught the children anything would probably have to have teaching qualifications, bur Mr. Kobayashi didn't worry about things like that. He thought it important for children to learn by actually seeing things done.

“Let's begin then,” said the farming teacher.

The place where they were assembled was besides the Kuhonbutsu pond and it was a particularly quiet section--a pleasant place, where the pond was shaded by trees. The headmaster had already had part of a railroad car put there for storing the children's farming implements, such as spades and hoes. The half-car had a peaceful look, neatly placed as it was right in the middle of the plot they were going to cultivate.

The farming teacher told the children to spades and hoes from the car and started them on weeding. He told them all about weeds: how hardy they were; how some grew faster than crops and hid the sun from them; how weeds were good hiding places for bad insects; and how weeds could be a nuisance by taking all the nourishment from the soil. He taught them one thing after another. And while he talked, his hands never stopped pulling out weeds. The children did the same. Then the teacher showed them how to hoe; how to make furrows; how to spread fertilizer; and everything else you had to do to grow things in a field, explaining as he demonstrated.

A little snake put its head out and very nearly bit the hand of Ta-chan, one of the older boys, but the farming teacher reassured him, "The snakes here ain't poisonous. and they won't hurt you if you don't hurt them."

Besides teaching the children how to plant a field, the farming teacher told them interesting things about insects, birds, and butterflies, about the weather, and about all sorts of other things. His strong gnarled hands seemed to attest that everything he told the children, he had found out himself through experience.

The children were dripping with perspiration when they had finally finished planting the field with the teacher's help. Except for a few furrows that were a bit uneven, it was an impeccable field, whichever way you looked at it.

From that day onward, the children held that farmer in high esteem, and whenever they saw him, even at a distance, they would cry, "There's our farming teacher!" Whenever he had any fertilizer left he would bring it over and spread it on the children's field, and their crops grew well. Every day someone would visit the field and report to the head-master and the other children on how it was doing. The children learned to know the wonder and the joy of seeing the seeds they had planted themselves sprout. And whenever two or three of them were gathered together, talk would turn to the progress of their field.

Terrible things were beginning to happen in various parts of the world. But as the children discussed their tiny field - they were still enfolded in the very heart of peace.

Note:

Dilapidated – In a state of disrepair or ruin due to age or neglect.

Furrows – Long, narrow trenches made in the ground for planting seeds.

Implements – Tools or equipment used for a specific purpose.

Nuisance – Something or someone causing inconvenience or annoyance.

Perspiration – The process of sweating.

Esteem – Respect and admiration, often for someone or something.

Attest – Provide evidence or proof of something.

Gnarled – Rough and twisted, often due to age or hard work (usually describing hands or trees).

Impeccable – Flawless or without any mistakes.

B. True or false? If false, write the correct statement.

1. The headmaster introduced the new teacher as someone who would teach the children to farm.
2. The new teacher was wearing formal attire, including a necktie and dress shoes.
3. The teacher was recognized by Totto-chan as a farmer she had seen before.
4. The children were assembled in a classroom to begin their lesson.
5. The farming teacher reassured Totto-chan that the snakes around the area were not poisonous.
6. The teacher used both hands and words to explain how to plant the field.
7. The children planted the field with the farming teacher's help, but it was messy and uneven.
8. Despite the terrible things happening in the world, the children felt a sense of peace while working on their field.

C. Answer the questions below:

1. Who introduced the new teacher to the children?
2. What did the new teacher wear instead of shoes?
3. What were the children going to learn from the farming teacher?
4. How did the farming teacher reassure Totto-chan about the snake?
5. What did the children feel when they saw the seeds they planted start to

D. Have you worked in a crop field before? Share your experience with your friends in the class.

Lesson 5: We Lost Our Home

A. Look at the image and discuss in groups the possible answers to the questions.



- 1) What do you see in this picture?
- 2) Do you think this lake is natural? Explain.
- 3) What are things that you know about Kaptai Lake situated in Rangamati, Bangladesh?

Hakkonchandra village was situated to the east of Kaptai dam, in the Rangamati district of the Chittagong Hill Tracts (CHT). A family in that village who belonged to the Boro Hambe clan had a son who was an ivory craftsman and was later recognized and appreciated as one of the very first craftsmen among the Jumma population in the CHT region. His niece is the mother whose story is given here.

It is difficult to say exactly when she was born, but she thinks she is over eighty years old now. She is my grandmother and one of the eyewitnesses of the discussed episode in the history of CHT. Her family was relatively affluent. She had six siblings—three brothers and three sisters. Their family was well-respected in the neighborhood since their father was a schoolteacher. Sushama Chakma was not acquainted with paucity and poverty in the early years of her life. When the northern parts of CHT were submerged permanently due to Kaptai dam, not just the Chakma population but some Hajong, Marma and adi-Bangali residents who had lived for long among us also lost all their possessions. The wealthiest families became displaced people. They had to constantly move from one place to the other. About 50,000 Chakma, Hajong, and Tripuri people had to leave the country and migrate permanently.

Like many others, she lost a secure life and her homeland with her relatives. Her husband had to leave his public service to live like a refugee. Her only possessions were memories of better times and the determination to survive. While moving from one location to another for resettlement in the reserve forest, they spent countless sleepless nights thinking about their uncertain future. Despite the constant struggle to find happiness in pain, the sun never shone for her family.

(This excerpt is taken from The Bangladesh Environmental Humanities Reader)
Forma-8, English For Today Class-8

B. Match the words in Column A with their correct meanings in Column B.

Column A	Column B
1. Affluent	A. To leave one's country permanently
2. Paucity	B. A feeling of uncertainty or anxiety
3. Displaced	C. Wealthy or having an abundance
4. Refugee	D. A lack of something, scarcity
5. Permanent	E. Forced to leave one's home
6. Resettlement	F. Lasting or intended to last forever
7. Possessions	G. A process of establishing a new residence
8. Migration	H. Items owned or held by someone
9. Struggle	I. A difficult fight or effort
10. Uncertain	J. To move from one place to another

C. Complete the paragraph by the clues given below.

flee, resettlement, east, refugee, flooded, ivory

Hakkonchandra village, located _____ of the Kaptai Dam in the Rangamati district, was home to a family from the Boro Hambe clan. Their son became a renowned _____ craftsman among the Jumma community. His niece, Sushama Chakma, my grandmother, is now over eighty and witnessed significant historical events. Her family was prosperous, with six siblings, thanks to their father's work as a schoolteacher. However, when the Kaptai Dam _____ northern CHT, many, including Chakma and Hajong people, lost everything. About 50,000 individuals had to _____ to India, including Sushama, who lost her stable life. Her husband became a _____, and all they had were memories and a will to survive. They endured sleepless nights during their _____ in the forest, struggling with an uncertain future, and happiness eluded them.

D. Answer to the following questions.

1. How many siblings did Sushama Chakma have?
2. What happened to the land when the Kaptai Dam was built?
3. What did Sushama and her family lose after they had to move?

E. Find out if anyone from your family have visited the Kaptai Lake in Rangamati? If so, listen to their experience and share it with the class.

Unit Six

Going on a Trip



After we have studied this unit, we will be able to

- listen for information
- listen to and follow announcements
- read and understand texts
- ask and answer questions
- write answers to questions
- write the main ideas

Lesson 1: At the Airport

Key words: lounge immigration

A Look at the picture and talk about it.



- 1 What do you see?
- 2 Can you guess where it could be?
- 3 Who are the people in the picture?
- 4 What could be their relationship?

B Now read the text and find out if your guesses are correct.

Zara lives with her parents in London. They have come to Bangladesh to visit Zara's aunt and uncle. She is very close to her cousin Mita. Both the families have visited many interesting places together in Bangladesh. It was great fun. Then they decided that they would visit some places outside Bangladesh too. They decided to go to Thailand. But Mita's parents were too busy with their work, so they could not go. However, Mita was going with them.

Mita, Zara and her parents are at Hazrat Shahjalal International Airport. They are waiting in the lounge. Mita is very excited. This is the first time that she is travelling on a plane. They are flying by Bangladesh Biman. Mita is hoping to have a great time in Thailand.

As they wait, the two cousins start planning what they would do once they reach Bangkok. Mita's uncle brings forms for all of them to fill in before going

through the immigration. He gives one to Mita and says, "You have to give some information about yourself in the form. The immigration officer will check your passport and stamp it. And then you are ready to travel." Mita, Zara and her parents start filling in the forms.

C Read the text again and answer the following questions.

- 1 Why is Mita excited?
- 2 Why aren't Mita's parents going with her?
- 3 What does an immigration officer do at the airport?

D Write a short composition about your experience of travelling to another place. It could be going to your grandparents'/aunt's/sister's/brother's house. Write about your preparation before traveling, your experience of the way, e.g. launch terminal, railway/bus station, airport, etc.

Lesson 2: Filling in a form

Key words: expire renew visa valid

A Read the card and discuss in pairs.



গণপ্রজাতন্ত্রী বাংলাদেশ সরকার
Govt. of the People's Republic of Bangladesh
(পরিদর্শন কার্ড/Departure Card)

1. নাম Name		3. জন্ম তারিখ Date of Birth	
2. লেঙ্গ Sex <input type="checkbox"/> পুরুষ Male <input type="checkbox"/> মহিলা Female		Day Month Year	
4. জাতীয়তা Nationality		Day Month Year	
5. পাসপোর্ট নম্বর Passport Number		6. ভিসা উত্তীর্ণের তারিখ Date of Expiry	
7. ফ্লাইট নম্বর Flight Number		8. প্রস্থানের তারিখ Date of Departure	
9. বাংলাদেশে অবস্থানকারী ঠিকানা (বিদেশী নাগরিকের জন্য) Address in Bangladesh (For Foreigners)			
10. বাংলাদেশের নাগরিকের জন্য For Bangladesh Nationals			
a. ভিসা নম্বর Visa Number		b. ভিসা উত্তীর্ণের তারিখ Date of Expiry	
c. ভিসার প্রকার Type of Visa		d. ভ্রমণের উদ্দেশ্য Purpose of Visit	
সীল Seal			
যাত্রীর স্বাক্ষর Passenger's Signature			
তারিখ: Date		Day Month Year	

B Now, read the text about Mita, and fill in the departure card in section A on her behalf.

Mita's full name is Mita Sultana Ahmed. She was born on 6 May 1998. She got her passport on June 09, 2010. It is a five-year passport. It will expire on 8 June 2015. After that she has to renew her passport. Her passport number is AB 9842251. She is going to Thailand by Bangladesh Biman, flight number BG 88 on 14 July 2012.

Mita got her visa from the Royal Thai Embassy in Dhaka. Her visa number is T 9115138. The visa was issued in Dhaka on 29 June 2012. The visa is valid for three months. It will expire on September 27, 2012. It is a tourist visa. If you are travelling on a tourist visa, you are not allowed to study or work there.

C Imagine you are travelling to a foreign country. Copy the form in A and fill in with your own information. If you have a passport, use information from it. If you do not have a passport, make your imaginary passport with visa number and expiry date, passport number, date of travel, etc.

D Work in pairs. If you have a passport, tell your partner when you got it and which country/countries you have already visited. If you do not have a passport, would you like to have one? Why?

Lesson 3: Going Through Immigration

Key words : departure booth counter scan machine readable

A Look at the pictures and discuss in pairs.

1



2



- 1 Why does a person need a passport?
- 2 What are those booths for?
- 3 Why are people standing in a line in front of them?
- 4 What are the persons doing inside the booth?

B Read the text and answer the questions.

Zara's parents Mrs Jhuma Islam, Mr Mazharul Islam, Zara and Mita, fill in their departure cards and move towards the immigration counter. Mita stands in front of one of the booths. She hands in her passport and the departure card to the officer.

The immigration officer goes through Mita's passport, visa and the departure card. "Are you travelling alone?" asks the officer. "No. I'm going with my aunt, uncle and cousin," says Mita.

"They are right there on that counter."

"Is this your first visit to Thailand?"

"Yes."

"How long are you going to stay there?"

"Seven to ten days."

"Where are you going to stay?"

" In a hotel."

The officer is talking as well as going through Mita's papers. He finds the papers OK. He smiles and stamps her passport. The officer keeps the departure card, and returns the passport to Mita.

"Have a safe journey."

"Thanks."

Mita waits for her aunt, uncle and Zara on the other side of the immigration. Once all of them are done, they walk towards the passengers' departure lounge.

C Make a list in the following grid showing what the immigration officer asks and tells Mita, and what Mita says in response. One is done for you.

Immigration officer	Mita
1 Are you travelling alone?	1 No. I'm travelling with my aunt, uncle and cousin.
2	2
3	3
•	•
•	•

D Now work in pairs and act out the role of Mita and the immigration officer.

E What are the three things needed at immigration?

Lesson 4: Boarding the Plane

Key words: seize enclosed formality gel

A Read the text and answer the following questions.

Mita, Zara, Mr and Mrs Islam all sit at the lounge. They all have hand luggage with them. Mr Islam asks, "Mita, Zara, are you two carrying any liquid, lotion, gel or cream in your carry-on luggage?" "I have a small lip gel in it. Why Uncle?" "Well, if it is a very small one, there is no problem. But if you've more than 100 ml, you have to put it in the checked-in luggage. These are not allowed on board in hand luggage. For security reasons, the officials who do the baggage checking will seize and throw them away". Mita, Zara, Jhuma Islam and Mazharul Islam go through the security checking and wait in the enclosed area. All the formalities are done. Now they are waiting to board the plane.

Mita, Zara and her parents board the plane after their row number is announced. Mita gets a window seat. Her seat number is F23 C. Zara sits beside her on an aisle seat and her parents sit behind them.

Questions

- 1 Who had a small lip gel in the hand luggage?
- 2 How much liquid or gel is allowed to carry in hand luggage?

3 Why are liquid, gel and cream not allowed on board a plane?

4 Which row is Mita sitting in?

B Listen to the teacher/CD and complete the chart. First one is done for you.

U1, L4 B

Listening text: 3

Announcement	Information
1. Destination	1. Bangkok
2. Name of the Airways	2.
3. Flight no.	3.
4. Row numbers of passengers called first to board	4.
5. Rows called for boarding last	5.
6. Final call for boarding	6.

Lesson 5: Announcements on Board (1)

Key words: lavatory cruising altitude descend schedule destination

A Look at the picture and talk about it.



B Read the announcement carefully and fill in the blanks below.

Ladies and gentlemen, welcome on board Flight BG88 to Bangkok. We are currently third in line for take-off and are expected to be in the air in approximately seven minutes. Please fasten your seat belt and secure all baggage under your seat or in the overhead compartments. Keep your seats and table trays in upright position for take-off. Please turn off all personal electronic devices, including laptops and cellphones. This is a non-smoking flight. Smoking in the lavatory is prohibited. Thank you for choosing Bangladesh Biman. Enjoy your flight.

- 1 The plane is _____ in line to take off.
- 2 The passengers are requested to fasten their _____.
- 3 All baggage to be kept _____ the seat or in the _____ compartments.
- 4 The seats are to be in _____ position.
- 5 All personal _____ devices are to be turned off.
- 6 It is a _____ flight.

C Read the questions carefully. Then read the following announcement on board flight BG 88 and answer the questions in short.

- 1 Who is speaking?
- 2 What is the airspeed of the plane per hour?
- 3 What's the time mentioned in the announcement?
- 4 How is the weather?
- 5 What's the temperature in Bangkok mentioned in the announcement?
- 6 Who will serve snacks and drinks?

Good afternoon passengers. This is your captain Rashid Akbar speaking. First I'd like to welcome everyone on Flight BG 88. We are currently cruising at an altitude of 10058.40 feet at airspeed of 643.7376 km per hour. The time is 1:25 pm. The weather looks good and with the tailwind on our side we are expecting to land in Bangkok approximately fifteen minutes ahead of schedule. The weather in Bangkok is clear and sunny. The temperature is 32 degree Celsius for this afternoon. If the weather is good we should get a great view of the city as we descend. The cabin crew will be coming around in about twenty minute's time to offer you a light snack and drinks. The inflight movie will begin shortly after that. I'll talk to you again before we reach our destination. Until then, sit back, and enjoy the flight.

Lesson 6: Announcements on Board (2)

Key words: exit locate monitored assistance secure assume bracing-position pouch firmly turbulence

A Look at the picture and talk about what the cabin crew is doing and why she is doing so.



B Listen to the teacher/CD and answer the questions.

U1, L6 B
Listening text: 4

- 1 What is the announcement about?
- 2 How many times has the word 'belt' been said in the announcement?
- 3 What will you do to fasten your seat belt?
- 4 What will you do to unfasten your seat belt?

C Read the text silently and do the exercises given in section D & E.

Oxygen and the air pressure are always being monitored. In the event of a lack of oxygen, an oxygen mask will automatically appear in front of you. Pull the mask towards you and place it firmly over your nose and mouth. Secure the elastic band behind your head, and breathe normally. If you are travelling with a child or someone who requires assistance, secure your mask first, and then assist the other person. Keep your mask on until a uniformed crew member advises you to remove it.

In the event of an emergency, please assume the bracing position. That is, lean forward with your hands on top of your head and your elbows against your thighs. Ensure your feet are flat on the floor.

A life vest is located in a pouch under your seat or between the armrests. When instructed to do so, open the plastic pouch and remove the vest. Slip it over your head. Pass the straps around your waist and adjust at the front. To inflate the vest, pull firmly on the red cord, before you leave the aircraft. We remind you that this is a nonsmoking flight.

You will find this and all the other safety information in the card located in the seat pocket in front of you. We strongly suggest you read it before takeoff. If you have any questions, please don't hesitate to ask one of our crew members. We wish you all an enjoyable flight.

(Adapted from: English club.com, airodyssey.net)

D Read the announcement again and match the sentence parts in A with those in B in the following table. Then write the sentences in your exercise book.

A	B
1 Oxygen and air pressure	a) under the seat or between the armrests.
2 If you are travelling with a child	b) are used to draw attention.
3 Life vests are placed	c) is kept in the seat pocket.
4 The whistle and light	d) put the mask on your nose and mouth first and then help the child.
5 The card with other safety information	e) are always monitored.

E Choose the best answer.

- There are more than two emergency exits in the aircraft. Here 'exits' means
 - doors
 - departures
 - windows
 - seats
- In the announcement, the cabin crew asked each passenger to ----- their life vest.
 - trace
 - take
 - find
 - uncover
- During emergency, the passengers are requested to assume the bracing position. Here, 'assume' means-
 - take on
 - suppose
 - shoulder
 - change

4 The cabin crew with their nice behaviour made all the passengers feel safe and when the plane was bumping.

- a) worried
- b) fixed
- c) happy

Lesson 7: Reaching Bangkok

Key words: derived parallel cargo capacity

A Look at the picture and talk about it.



- 1 What do you see in the picture?
- 2 What could be this place?
- 3 How do you know?

B Read the text and complete the chart.

The plane landed at Suvarnabhumi Airport at 4:55 p.m. The name ‘Suvarnabhumi’ is pronounced as “su-wan-na-poom”. The name is derived from Sanskrit, which means golden land. The name was chosen by King Bhumibol Adulyadie.

The airport is located in Racha Thewa in the Bang Phli district of Samut Prakan province, 30 kilometres east of Bangkok.

The airport has two parallel runways. Both of them are 60 metre wide. One of the runways is 4000 metres long and the other is 3,700 metres. It can handle 76 flight operations per hour. It can handle 45 million passengers and 3 million tonnes of cargo per year.

The airport passenger terminal is 563,000 square metres that is, 6,060,000 square feet. It is the fourth biggest passenger terminal building in the world. The airport is going through phase 2. It will raise its capacity to handle 65 million passengers per year. The airport has two 5-storey car park buildings. The buildings can house 5000 cars.

Bangkok Airport	Information
1 name	
2 origin of the name	
3 chosen by	
4 meaning	
5 distance from Bangkok	
6 runway	
7 length of runways	
8 aircraft control per hour	
9 number of passengers	
10 cargo handled	
11 car parking	
12 number of passengers in future	

C Listen to the teacher/CD and circle the correct information.

U1, L7 C
Listening text: 5

Questions

Suvarnabhumi Airport has

- 1 checkpoints for arrivals: 130/131/132
- 2 checkpoints for departures : 70/71/72
- 3 custom control checkpoints for arrivals: 25/26/27
- 4 custom control checkpoints for departures: 4/6/8
- 5 baggage conveyor belts: 20/22/24
- 6 check-in counters: 360/361/362
- 7 moving walkways: 106/107/108
- 8 elevators: 102/103/104
- 9 escalators: 81/82/83

Lesson 8: The Destination

Key words: fascinate destination floating market

A Read the text below and complete it with the right form of verb from the box. You can use one verb more than once if necessary.

be wait give excited nod go hold take ride stand

Mita was _____ to see such a big airport. After completing immigration, they all came out of the airport. Mr. Mazharul Islam _____ to the taxi counter and bought a ticket. They stood in a line and _____ for *their turn*. Soon their taxi came and they all got into it.

Mita's uncle _____ the driver his address, Happy Condo 18 Rachada Pisek Road. The driver _____ and started for the destination. Mita _____ very excited. She _____ Zara's hand and whispered, "Oh Zara, I can't believe I'm here with you and I'm so happy. Mita had never _____ a car at such a high speed. She _____ *a little scared*. It _____ about one and a half hours to reach their destination. Mita's uncle paid the driver according to the metre. The driver _____ out their luggage, thanked Mr. Islam and drove away.

B Read the text and answer the following questions.

Mita looked around and saw a garden of trees and flowers welcoming her. There was a small fountain at the middle of the garden, bringing in cool breeze. Mita loved the place.

Mita brought a suitcase as well as a piece of carry-on luggage. She carried her luggage to the elevator and pressed a button that *said 6*. Her uncle's apartment was on the 7th floor. It was a nicely done two-bedroom apartment. Mita and Zara were going to share the same room.

It was nearly 8 p.m. when they all *got settled*. They finished dinner and started to plan for the next day. Mita read about the floating market in the internet, and wanted to see one. "Well, then you have to wake up very early tomorrow. The market sits early in the morning and is over before noon. We are going to the Tha Kha floating market tomorrow," said Mr. Islam. "Wow!" cried out Mita and Zara together. "Thank you, uncle." "Thank you, dad."

Questions

- 1 Why did Mita think that the garden was welcoming her?
- 2 When did they all start to plan for the next day?
- 3 What did they plan to see?
- 4 Why would Mita and Zara wake up early the next morning?

C Read the text in A and B and write what the following phrases mean in the texts.

- 1 their turn
- 2 a little scared
- 3 bringing in
- 4 said 6
- 5 got settled

Lesson 9: The Tha Kha Floating Market

Key words : laden chit-chat natives

A Look at the picture and talk about it.



- 1 Can you guess what this could be?
- 2 Where do you think this place is?

B Read the text and answer the questions.

It was Sunday. Mita, Zara, Jhuma Islam and Mazharul Islam woke up very early. They quickly got ready and started for Tha Kha floating market. They planned to have breakfast at the market. They reached the market place sharp at 7. The canals were surrounded with coconut palm trees. They hired a boat. The boatman started to row slowly taking them to the centre of the market.

There were boats everywhere. The sellers were mainly elderly Thai women. Their small boats were laden with bundles of lotus flowers, farm-fresh coconuts,

fruits, vegetables, local food, and delicious sweets. The sellers and buyers rowed their boats slowly. The sellers displayed their goods for sale and the buyers chose their pick. They could have a little chit-chat as buying and selling was going on.

- 1 What kind of market was it?
- 2 Why did the boatman row slowly?
- 3 Who were selling goods? How were they selling their goods?
- 4 What were they selling?
- 5 What was the atmosphere at the market?

C Read more about the Tha Kha river and Mita's experience.

The Tha Kha floating market is more traditional with a few tourists visiting than other floating markets. Originally, the Tha Kha floating market used to sit only six or seven days a month depending on the phase of the moon. Nowadays, the trade takes place on Fridays, Saturdays and Sundays too. The main buyers here are the Tha Kha natives. People seem to know each other very well. Everyone was seen smiling and calling each other by name. The locals did not notice Mita and others much. They were all busy buying and selling.

D True or false? If false give the correct information.

- 1 Tha Kha floating market is a tourist place.
- 2 It sits only six or seven days a month.
- 3 The buyers and sellers are the local people living near Tha Kha river.
- 4 They all knew each other.

E Read the text further and write the answers to the following questions.

- 1 Why is Tha Kha floating market 'traditional'?
- 2 How many days a week does the market sit?
- 3 Why do you think people at the floating market know each other so well?

F Read the text and answer the following questions.

They passed an hour and a half at the market and enjoyed the business. Then all of them were hungry. They rowed near the boat of an elderly woman, who was selling food. She welcomed them with a smile and showed them the food. They bought the traditional and very popular food called 'Pad Thai', a kind of noodles with shrimps, tomato and some vegetables, with freshly roasted crushed peanut. The food was served in a bowl made from banana leaf. After Pad Thai, they ate 'Kanom Krok'. It is a coconut pancake which is very sweet. The Tha Kha people are simple and easy going. They are very friendly and polite. They do not understand English or any other language. Yet they have a way to communicate with Mita and others.

Mita was delighted to see a traditional Thai floating market. She took a lot of pictures with the elderly sellers.

Questions

- 1 Who were hungry?
- 2 How did the elderly woman know that Mita and others want to buy food?
- 3 What does the phrase 'easy going' mean?

G Discuss in groups the following question and write the answer.

Do we have anything like a Tha Kha market in our country? If we have, where can you find it? If we don't have, discuss why we need it.

H Describe a nearby bazar/market in your locality by answering the following questions:

- a. What is the market called? (give its name if there is any) How far is it from your home?
- b. When does the market sit?
- c. What can you buy at the market?
- d. Do you like going to the market? Write why or why not.

Unit Seven

People and Occupations



After we have studied this unit, we will be able to

- read and understand texts through silent reading
- listen for information
- ask and answer questions
- write down the main ideas in our own words
- write short paragraphs

Lesson 1: Pearls! Pearls! Pearls!

Key words : mythology ancient dissolved status unparalleled association delicate

A Look at the pictures and discuss in pairs.



B Read the text and answer the questions that follow.

Thousands of years ago, the first pearl was probably discovered while human beings were searching for food at the sea shore. Throughout history, the pearl with its shine has been one of the most highly valued gems.

Pearls have been mentioned many times in religious texts and mythologies from the earliest times.

The ancient Egyptians valued pearls so much that they were buried with them. It is said that the famous queen of Egypt, Cleopatra would dissolve a pearl in a glass and drink it as a sign of love and respect for the entire nation.

The Greeks thought of pearls as a sign of wealth and social position. The beauty of pearls was associated with love and marriage.

In ancient Rome, pearls were considered the greatest sign of wealth and social status.

At that time the young women of noble families loved to wear beautiful pearl necklaces. The brave knights used to wear them in the battles for good luck.

Questions

- 1 Do you think 'pearls' were discovered by accident? Why?
- 2 Why do you think pearls were valued so much in the past?
- 3 What good luck did the knights think pearls would bring them?

C Read the text in B again and write the information in the table.

Who	When/ where		
The ancient Egyptians	wore	pearls	
The Greeks			
The ancient Romans			
The brave knights			

Lesson 2: The Ama Divers

Key words : rare descend hazardous rely

A Read the text and answer the following questions.

Before the beginning of the 20th century, pearls were obtained from pearl oysters. These oysters were collected from the bottom of the ocean, lake or river.

To get enough pearl oysters, free-divers were often forced to descend to a depth of more than 100 feet in one breath. Because of the difficulty of diving, pearls at that time were of different quality as well as very rare.

In Asia some pearl oysters could be found on shoals at a depth of 5–7 feet from the surface. At times the divers had to go 40 feet or even up to 125 feet deep to find enough pearl oysters. These deep dives were extremely hazardous to the divers.

Questions

- 1 What is the text about?
- 2 Where did the people get the pearls from?

B Read about the Ama divers of Japan. Discuss in pairs the information that you have got from the text and answer the questions.

In some fishing villages along the coast of Japan, there are amazing groups of women known as 'Ama divers'. These women worked and are still working as Ama. The word 'Ama' means 'women of the sea or sea women'. They are independent divers. They make their living by diving. They can dive to the depth of the sea up to 25 metres. And they dive without using oxygen tanks or other breathing equipment.

The Ama divers rely on their own skills and breathing techniques. They use that skill and technique to push themselves down to the bottom of the sea and back to the surface again. They can hold their breath for up to two minutes. Careful watching, lung capacity and hunter instincts are the special qualities of Ama divers.

However some of these young villagers are now going to the city in search of other jobs. The remaining Ama divers are now aged between 50 and 60. But there are still some who continue to dive even at their 70s. If the young people do not take up Ama diving, soon this profession will die out.

Questions

- 1 Why are the Ama divers amazing?
- 2 How deep can the Ama divers go down into the sea?
- 3 What techniques and skills do the Ama divers use in diving?
- 4 Why do you think the young villagers are going to the city?

Lesson 3: River Gypsies in Bangladesh (1)

Key words : gypsy ethnic nomadic roam tarpaulin tents remedy vend heal talisman

A Look at the pictures and discuss with your partner what you see

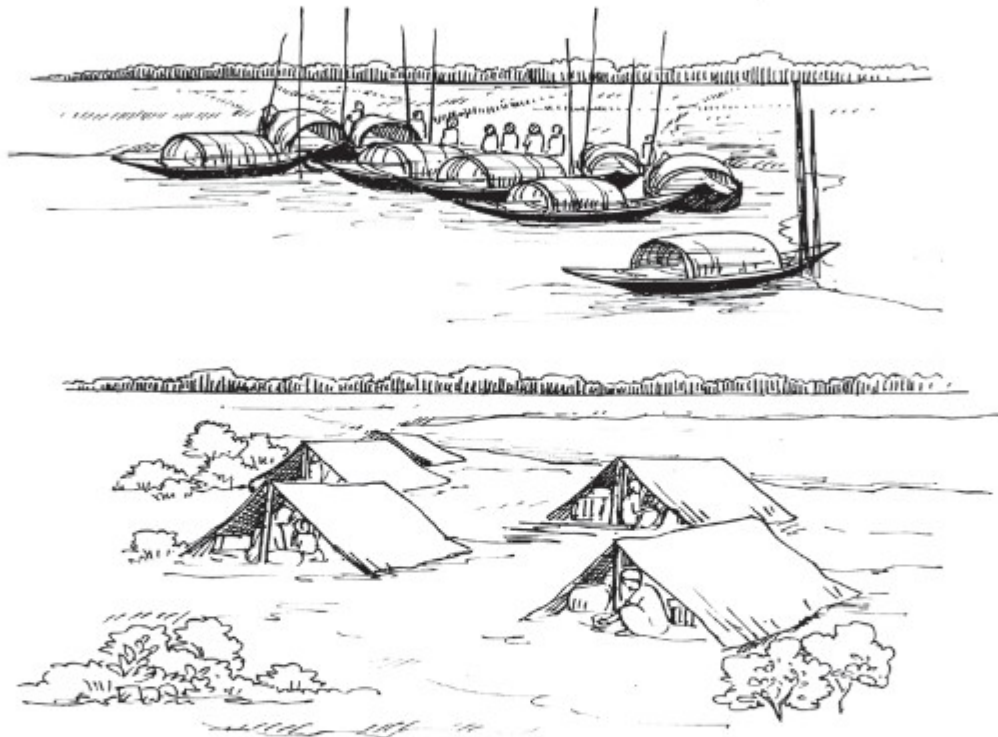

Read the text and answer the following questions.

River gypsies are an ethnic group of people in Bangladesh. They are known as *bedey* to local people. The gypsies have their own lifestyle and culture. They live in groups and do not own any land. Therefore, they live a nomadic life, travelling from one place to another. These people roam across our rivers and waters from May to December in small country boats. These boats are their houses and these people are a part of our waters. In winter, many water bodies dry up. At that time they return to the mainland and live in make-shift tarpaulin tents on open river banks. You can see their men relaxing in the tents. Toddlers play with dogs or other pets in the dust. Women often idle away time by picking off lice in twos or threes sitting in a row.

Throughout the monsoon, they remain busy with fishing. They also dive for natural pearls in waters. Sometimes, they camp for a couple of weeks. Men catch snakes and entertain people with snake charming and sell herbal cures. Women go from door to door to selling bangles, cosmetics and other things. They also try to heal pains of old people by sucking out blood from their body.

Many villagers believe in the magical power of the gypsies. They can make an evil spirit leave someone's body by magic or special powers.

Questions

- 1 Who are river gypsies?
- 2 How do they live?
- 3 What do river gypsies do in winter?
- 4 What do river gypsy men do for a living?
- 5 What do river gypsy women do for a living?

B Discuss with your partner and circle the right answer.

1 The term 'ethnic' is connected to

- | | |
|------------|-----------|
| a people. | b plants. |
| c animals. | d fishes. |

2 River gypsies roam around on their boats aboutmonths a year.

- | | |
|---------|---------|
| a six | b seven |
| c eight | d nine |

3 River gypsies live in tents in

- | | |
|------------|-----------|
| a summer. | b winter. |
| c monsoon. | d spring. |

4 The term 'nomadic' refers to a person who

- | | |
|---------------------------------|--------------------------------|
| a stays permanently at a place. | b travels from place to place. |
| c lives in one's own house. | d lives in a rented house. |

C Listen to the teacher/CD and fill in the following gaps with right word/s.

U7, L3 C
Listening text: 6

- 1 The river gypsies are among the Nation's ----- groups.
- 2 A 2007 report said ----- percent live below the poverty line.
- 3 Only 2 percent of gypsy children are given primary -----.
- 4 Most gypsy children travel with their parents for an ----- 8 months of the year.
- 5 So, they end up in a cycle of -----.

D In summer vacation last May, Sohan went to Lauhajang in Munshigonj to visit his maternal uncle. His elder cousin, Jihan studies sociology at Dhaka University. One afternoon, Jihan took Sohan to a *bedey* camp to know about their life. They talked to a middle aged *bedey* woman who was cooking in front of her tent. Read the conversation and do the following activity.

- Jihan : Good afternoon. Can I ask you a few questions ?
- Woman : Good afternoon. Umm..... you see I'm busy cooking. I've to feed my son and then...
- Jihan : Well, I won't take much time. Just a few questions if you please....
How long have you been here in this camp?
- Woman : Four months. Since last January. And if it rains, we're going to rivers again next month.
- Jihan : What do you do for a living?
- Woman : We catch fish. Our men are snake charmers and we heal toothache and joint pains of old people.
- Jihan : How do you heal people?
- Woman : With traditional herbs and healing art.
- Jihan : Well, if you don't mind, how much do you earn?
- Woman : Not enough. About 3000 taka per month. Now many people don't believe in our remedies. They go to doctors. So we go to remote villages...
- Jihan : What about your son? I guess he is already 5. Does he go to school?
- Woman : Not yet. But I've heard about mobile boat-schools in rivers. I'll try to find one for my son.

- E Suppose you were with Sohan. Ask the *bedey* woman some more questions. For example, you can ask questions to know about her family members, their names, age, work, their past living places, future plans, food habit, etc.
- F Have you ever seen any *gypsies/bedey/snake charmers* or any person selling things from door to door in your area? Write your experience about any one of them.

Lesson 4: River Gypsies in Bangladesh (2)

Key words : survive used to inherit mainstream petty trick integral part
community settle urbanise (v) urban (adj)

- A Look at the pictures. Discuss with your partner and say who they are, where they are, what they are doing, etc.



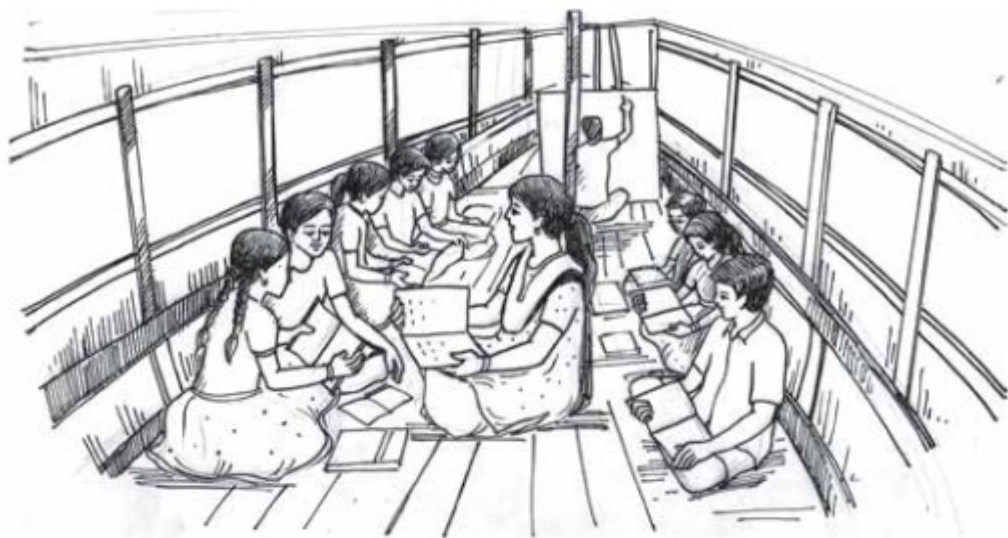

B Read the text and answer the following questions.

River gypsies in Bangladesh face various problems. First, Bangladesh is getting urbanised very rapidly. Gypsy people are losing their customers among the urban population. Hence, their income is threatened. Secondly, 24,000 kilometres of previous waterways shrink to only 6,000 kilometres in the country in dry seasons.

Scientists believe that Bangladesh will be worst affected by global climate change. The unpredictable rain and drying out of rivers have made boat movement heavily restricted. Thirdly, many river gypsies are changing their lifestyle in the context of changed reality. They are thinking of living permanently on land. The state feels that river gypsies need help to survive in the mainstream population. Therefore, the government is offering voting rights, permanent housing and bank-loan facilities. However, changes do not come overnight.

Traditionally, river gypsies are used to water life. They have inherited from their forefathers necessary life skills to survive in water. They have no education and training to adapt to mainstream modern society. So the state feels the need to bring them under formal education network. But they have no permanent living place. Gypsy children are born and brought up on the boats. Therefore, they cannot go to conventional schools. And hence,

mobile boat-schools are being established for gypsy children. Some voluntary organisations are running special schools on boats to educate river gypsy children in some areas.

Questions

- 1 What are the main problems that river gypsies are facing?
- 2 What is the effect of global climate change in Bangladesh?
- 3 Why are many river gypsies thinking of changing their lifestyle?
- 4 Why can't river gypsy children go to conventional schools?
- 5 Who are running special schools for river gypsy children? Why?

C Listen to the teacher/CD and tick the best answer.

U7, L4 C Listening text: 7

- 1 *Bedeys* catch snakes during the winter/rainy/summer season.
- 2 Females of the *bedey* families contribute to the family income/education/health with petty trades.
- 3 They sometimes go vending far from home by rickshaw/ on foot/ by cart.
- 4 Many *bedeys* have settled near the riverbanks/lakesides/seashore.
- 5 *Bedeys* are an integral part of our history and literature/culture/tradition.

D Imagine there is a boat-school in your area to teach river gypsy children. Write a short composition about how you can help the gypsy children with learning.

Lesson 5: Refugees

- A. Look at the picture and discuss in groups the possible answers to the questions**



Illustration: Dan Williams

1. What comes first in your mind when you look at the image?
2. What is the relationship between the child and the man?

- B. Now read the text titled “Sea Prayer” by Khaled Hosseini and answer the questions that follow:**

My dear Marwan, in the long summers of childhood, when I was a boy the age you are now, your uncles and I spread our mattress on the roof of your grandfather's farmhouse outside of Homs.

We woke in the mornings to the stirring of olive trees in the breeze, to the bleating of your grandmother's goat, the clanking of her cooking pots, the air cool and the sun a pale rim of persimmon to the east.

We took you there when you were a toddler.

I have a sharply etched memory of your mother from that trip, showing you a herd of cows grazing in a field blown through with wild flowers.

I wish you hadn't been so young.

You wouldn't have forgotten the farmhouse, the soot of its stone walls, the creek where your uncles and I built a thousand boyhood dams.

I wish you remembered Homs as I do, Marwan.

In its bustling Old City, a mosque for us Muslims, a church for our Christian neighbours, and a grand souk for us all to haggle over gold pendants and fresh produce and bridal dresses.

I wish you remembered the crowded lanes smelling of fried kibbeh and the evening walks we took with your mother around Clock Tower Square.

But that life, that time, seems like a dream now, even to me, like some long-dissolved rumour.

First came the protests. Then the siege.

The skies spitting bombs. Starvation. Burials. These are the things you know. You know a bomb crater can be made into a swimming hole. You have learned dark blood is better news than bright.

You have learned that mothers and sisters and classmates can be found in narrow gaps between concrete, bricks and exposed beams, little patches of sunlit skin shining in the dark.

Your mother is here tonight, Marwan, with us, on this cold and moonlit beach, among the crying babies and the women worrying in tongues we don't speak. Afghans and Somalis and Iraqis and Eritreans and Syrians. All of us impatient for sunrise, all of us in dread of it. All of us in search of home.

I have heard it said we are the uninvited.

We are the unwelcome. We should take our misfortune elsewhere.

But I hear your mother's voice, over the tide, and she whispers in my ear, "Oh, but if they saw, my darling. Even half of what you have.

If only they saw. They would say kinder things, surely."

I look at your profile in the glow of this three-quarter moon, my boy, your eyelashes like calligraphy, closed in guileless sleep.

I said to you, "Hold my hand. Nothing bad will happen."

These are only words. A father's tricks. It slays your father, your faith in him. Because all I can think tonight is how deep the sea, and how vast, how indifferent. How powerless I am to protect you from it. All I can do is pray.

Pray God steers the vessel true, when the shores slip out of eyeshot and we are a flyspeck in the heaving waters, pitching and tilting, easily swallowed. Because you, you are precious cargo, Marwan, the most precious there ever was. I pray the sea knows this. Inshallah.

How I pray the sea knows this.

Note

Etched – Deeply marked or engraved in memory.

Persimmon – A type of orange fruit; here, it describes the pale color of the sun.

Soot – Black powder or ash left from fire or smoke.

Bustling – Full of energy and movement, busy.

Haggle – To bargain or argue over the price of something.

Siege – A military attack where enemies surround a place and cut off supplies.

Crater – A large hole made by an explosion.

Guileless – Innocent, without trickery or deceit.

Heaving – Moving up and down, as in the motion of the sea.

Flyspeck – Something very small, like a tiny dot.

Pitching – Moving up and down suddenly, especially in rough waters.

C. True or false? If false, write down the correct statement

1. Marwan's father recalls waking up to the sound of cars and traffic during his childhood summers.
2. Marwan's father remembers showing him a herd of cows when he was a toddler.
3. Marwan's father remembers building dams in the creek near the farmhouse when he was a boy.

4. Marwan's father feels powerless to protect him from the sea during their journey.
5. Marwan's family was taking a trip to the beach for a holiday.
6. Marwan's father says the Old City of Homs had both a mosque and a church.
7. Marwan's father believes the sea is friendly and will protect them on their journey.

D. Answer the questions below:

1. Where did Marwan's father and his brothers sleep during the summers of his childhood?
2. What sounds did Marwan's father wake up to in the mornings at the farmhouse?
3. What does Marwan's father wish Marwan remembered about Homs?
4. Why does Marwan's father feel worried about the sea during their journey?

E. "Sea Prayer" was inspired by the story of Alan Kurdi, a three-year-old Syrian refugee who drowned in the Mediterranean Sea in September 2015 while trying to reach safety in Europe. In the year after his death, 4,176 more people died or went missing on similar journeys. Imagine you are a refugee child. Write down how you would feel if you were one.

Unit Eight

News! News! News!



After we have studied this unit, we will be able to

- ask and answer questions
- participate in short dialogues and conversations on familiar topics
- read aloud texts with proper sounds, stress and intonation
- read and understand text materials
- write answers to questions
- write simple formal/informal letters
- write simple CVs
- write short paragraphs

Lesson 1: What is News?

Key words : bunk off mass people objective bias broadcast refer editorial
informative educative

A Look at the following pictures. Discuss with your partner what you see in them.



B Read the text and answer the following questions.

'I eat rice every day. I play cricket. I don't *bunk off* Madrasah, blah...blah... blah...!' These are common events. They happen every day or on some occasions. Are these events news? Should they be published in newspapers? The answer is a big 'NO'. Then what is news anyway? What do we want to know from the *media*? 'When a dog bites a man that is not news, but when a man bites a dog that is news,' says Charles Anderson Dana.

The first thing is that the news should be a piece of information. Secondly, the information should be recent or new, and hence it is 'news'. Thirdly, people should take interest in it. Fourthly, it should be self-explained. That is, it should answer all the questions with who, which, what, where, when, why and how. Finally, it should be *objective*. Recently, another aspect has been added: news is either printed or *broadcast* or on the internet.

There are opinions that the term 'news' comes from 'new'. Others say it is news because it comes from all directions: North, East, West and South.

Questions

- 1 What features should news have?
- 2 What is the difference between news and an event?
- 3 '.....it should be self-explained ...'. What does 'it' mean here?
- 4 What are the opinions about the term 'news'?
- 5 What must be there in the information in a newspaper?

C Pairwork. Find the following words/phrases in *italics* in the text in B. Discuss with your partner and try to guess their meaning from the context. Then look at the table below and match the words with their meanings in the right column. First one is done for you.

Word/phrase	meaning
bunk off	not influenced by personal feelings/opinions
media	to send out programmes on TV or radio
objective	ways of getting information e.g. Radio, TV, newspaper, etc.
broadcast	stay away/leave school/work without permission

D What is fake news?

"Fake news" means news that isn't true or is misleading. This can happen when stories don't have real facts or trustworthy sources.

There are two main types of fake news:

- 1. Misinformation:** This is when wrong information is shared by mistake, without meaning to mislead anyone.
- 2. Disinformation:** This is when wrong information is shared on purpose to trick people. It's important to always check facts to avoid spreading fake news!

E Look at the news and the post below and discuss the questions in pairs.



A news card falsely claims that Hillary Clinton has adopted an alien baby discovered at a UFO crash site.



A Facebook page falsely claims that Sonali Bank is giving away money to people in celebration of the month of victory.

Questions:

1. Do you think this news and the post are true? Why or why not?
2. Why do you think people are spreading this fake news?

F Look at the following comment.

The advertisement is the most truthful part of a newspaper. —Thomas Jefferson
Now, make similar sentences from the following substitution table.

The editorial page	is	the most attractive	part of a newspaper.
The cartoon page		the most educative	
The sports page		the most valuable	
The learners' page		the most interesting	

G Ask and answer with your partner.

- 1 Do you read any newspaper/magazine?
- 2 When do you usually read it?
- 3 Which newspaper/magazine do you read?
- 4 What makes it different from other newspapers/magazines?
- 5 Which news items do you like most ---- international affairs, sports, movie, culture, politics, etc?
- 6 Do you share your favourite news item/s with your friend/s?

H Write a paragraph on your habit of reading newspapers. You can take your cues from the questions in section G.

Lesson 2: The First Newspaper

A Work in pairs. Discuss the following questions.

- Do you read newspapers?
- What newspaper/s do you read and how often?
- What pages interest you the most?
- What do you know about the history of the newspapers?

B Read the text below silently and fast. Then tell what the text is about.

Humans have a natural curiosity to know the unknown, to see the unseen and to conquer the unconquered. Every day so many things are happening around and human beings are eager to know them all. They not only like to know happenings in their own and



Acta Diurna: the first newspaper

other countries, but also what is happening in Antarctica or Mars, or Siberia. This curiosity to know and understand situations is not a contemporary phenomenon. It is true, the world wide web (www) has made our life easier and

now we know anything that takes place at the farthest corners of the world with a single click. However, it was not that easy a few hundred years ago. Through a process of evolution, the newspaper has now become a part and parcel of human life. Modern people cannot think of a day when they don't have a newspaper passed through the doors in the early morning. A fresh newspaper with a hot cup of tea or coffee has been the symbol of modern urban life. We peep at a newspaper for national, local, international or sports news. Is there a show of *Nuruldiner Sarajibon*, or *Chitrangoda* or *Hamlet*? Is there a suitable job offer? Are there any sales? Let us have a look at the newspaper. The newspaper is the ultimate destination for advertisements of products, classified advertisements for finding brides and bridegrooms, houses to-let, sales, and what not? It is said, in the modern world, information is power and a newspaper is an information hub. But how were the initial days of the newspapers? The first newspaper, *Acta Diurna*, was published in ancient Rome in 59 BC. *Acta Diurna* meaning 'daily acts' posted different types of announcements and social events. However, *Acta Diurna* was not a paper-based newspaper. It was a message board displayed in public places. Just imagine how old the history of the newspaper in human civilization is! *Acta Diurna* was published just 59 years before the birth of Jesus Christ!

Much later, at the beginning of the 16th century, printed 'news books' were published in England and they were based on stories such as battles, disasters or public celebrations. The London Gazette claims to be England's oldest newspaper published in 1665. The 17th century also marks the regular publication of newspapers in Germany, Italy and the Netherlands. Johann Carolus published the first weekly newspaper, *Account of All Distinguished and Commemorable News*, from Germany in 1605. The newspapers that are delivered to your house each day started its journey from the 18th Century. *The Pennsylvania Packet* and *The Daily Advertiser* were the first daily newspapers from the US, which came out in 1784. Many independent newspapers ran before that on a weekly or monthly basis.

The first newspaper printed in India was Hickey's *Bengal Gazette* in 1780 under the British Raj. It was published by James Augustus Hickey. In this process, the first Bangla weekly newspaper, the *Samachar Darpon*, came out in 1818. The missionaries ran this newspaper. The *Azad* became Dhaka's first daily newspaper. The *Azad* played an important role during our language movement as the daily *Ittefaq* played glorious role in our struggle for independence.

In the 21st century, there is a change in the form and presentation of newspapers. They are no more confined to tabloid and broadsheet sizes. Nearly all the world's major newspapers have begun publishing online editions of their newspapers and although some newspapers charge their readers for access, many have made their web editions free. Yet, having a printed newspaper is still an obsession for many people in the world.

C Read the text above again and fill in the flow chart with relevant information. Why are these dates important in the history of newspapers?

Before the
birth of Christ

16th
century

17th
century

18th
century

19th
century

D Group work.

1. Do you agree with the statement in the text that newspaper with a cup of tea has been an urban trend? Why/Why not?
2. From your reading of the text in Section B, what difference do you find in the newspapers of the present time compared to those of the early days? Justify your arguments.

Language Point

Look at the sentence below.

Is there a show of Nuruldiner Sarajibon, or Chitrangoda or Hamlet?

There at the beginning of this sentence is called introductory there.

For example, There is a new movie at Cineplex.

There is sometimes used in the beginning of a sentence immediately before/after a form of verb 'to be' when the subject noun is an uncertain person or a thing. Here 'there' is not an actual subject, but enables the subject to follow the verb. This is called 'Introductory There'.

E Make a list of sentences that use 'Introductory *There*' in the text in Section B and then make five sentences using 'Introductory *There*'.

1. _____
2. _____
3. _____
4. _____
5. _____

F Read the following sentences. Write T if the statement is true and F if the statement is false and then provide correct answer.

1. It annoys people when the newspaper-man passes a newspaper through the door.
2. Newspapers more or less provide all sorts of information we need.
3. The first newspaper was published in England.
4. The history of newspaper dates back to recent time.
5. The Americans first introduced daily newspapers.
6. The Samachar Darpan came out once in seven days.
7. Online newspapers are common all over the world

G Here is a small story but the sequence of the sentences is jumbled. Work in groups to rearrange the sentences so that the text comes as a cohesive paragraph.

1. Rumki is very emotional and can't bear it.
2. Putting it on the dining table, she quickly makes her tea and comes back to it.
3. Then she takes some light freehand exercise, get freshened, puts some water in the kettle and waits for a soft sound.
4. Rumki gets up early in the morning every day.
5. She enjoys the page for entertainment, but she is sometimes upset with the death-news.
6. Within half an hour she hears the sound of the passing the newspaper through the door.
7. Before she takes her first sip of tea, she skims the headlines.
8. Collecting it, she takes a long sniff. She loves it.

Lesson 3: TV News Report

A Work with a partner and discuss what you see in the picture below.

B Read the text silently and answer the questions that follow.

Have you noticed TV reporters appearing on the screen with reports of different types of news? Have you thought how these reports are prepared? Scorching sun, monsoonal showers or bitter winter can never stop them from reaching



the news spot. The reports include political issues, people's protests, accidents, social events or thoughtful opinion of expert people, price hike, a celebration

after a cricket match win and what not? TV reporters do not miss or delay to cover them.

It is said that old news is no news. Consequently, there is always a hurry among the reporters to be up-to-date in developing stories or even break the story first. Breaking news has become popular among the viewers, it means the first and fast appearance of a startling news on the channels. Once a journalist has been assigned by his editor to cover a story, a team is formed. Usually it consists of a journalist, a camera operator and sometimes a sound and or a light technician also join as crew. The journalist investigates the topic, plans interviewing the relevant people and puts forward a concrete idea of the topic which is going to be filmed. The news team then goes out to cover the news and collect the materials. The voice over is then recorded in a studio usually by the journalist or a news presenter. This is the voice that the audience hear while the video clip moves on narrating the story and the reporter is not seen on the screen at that time. It is done to make the visual material and the full story clear to the audience with information and explanation. The editor may edit the report before it is ready to go on air, but often there may be live reporting of incidents.

A TV news report usually begins with an announcement. One or two short sentences explain what it is about. Then in the main report we see the reporter is describing an event into a microphone. To emphasize the significance of the situation, to show its authenticity, and to convey the feelings of the reporter and others involved, the reporter stands in front of the camera so that the audience can see what's going on in the background. The shots of the scene need to be easy to understand since it provides important visual information to the viewers. It depends on the skills of the camera operator.

In a TV report, there are usually comments or opinions from one to four persons who are related. These statements can be for or against a particular topic. TV news report can use graphics like charts, tables, graphs or archive materials like old photos or videos to make it more comprehensive and credible to the audience. In the concluding part, the reporter summarizes the possible outcomes of the story.

A live coverage of a news is different. Everything has to be finished on the spot and news video is aired instantly and in most cases without much pre-planning.

There is no chance of editing and very little chance for retaking the shot there. Quick intelligent decisions and prompt management of required technical assistance in a situation determines the quality of live reports.

Reporters need to be careful to keep camera shots short and to the point. They also need to use simple language, and speak clearly and concisely as there will be time constraints for each piece of report. In order to keep video shots steady, the camera operator often uses a tripod.

Questions

1. Does unfavorable weather condition stop a TV news reporter from covering a news?
2. What is a breaking news?
3. Why is voice over added to a TV news report?
4. How is a live news coverage different in making from recorded news story?
5. What are some points about which the TV reporters need to be careful?

C Read the following statements and say whether they are true or false. If false, give the true information.

- a. A TV news reporter does not use voice over in a live coverage.
- b. Graphics and archive materials are not at all necessary for TV news report.
- c. The reporter comes in front of the camera just to show himself.
- d. A camera person determines the quality of the shots in the scene.
- e. In the concluding part of the TV news report, the reporter gives his own opinion.

D Match the words or phrases from column A with similar meanings in column B and make sentences with them. One is done for you.

Column A	Column B
price hike	declaration
announcement	respondent
authenticity	records
coverage —————	reporting
on air	broadcast
graphics	increase in expense
archive	a three legged stand
interviewee	visual representation of data
tripods	actuality

E Here is a poem on news. Read it individually and then work in pairs to discuss what interesting news you get here.

The News

Here is The News:
'Two incredible shoes
Two incredible shoes
That's The News.

When it rains
They walk down drains.

They glow
in the snow.

They grizzle
in a drizzle.

They sneeze
in a breeze.

They sneeze
in a breeze.

They get warm
in a storm.

They go soggy
When it is foggy.

They've even hissed
in a mist.

But
(sad to say)
There comes a terrible frost.
This is what happened:
They got lost.'

That was The News
 'Two incredible shoes.
 Two incredible shoes.
 That was The News.

–*Michael Rosen*

F News- shoes, rains – drains are some rhyming words in the poem. What other rhyming words do you find in the poem? Work with your partner to find out their meanings.

G Suppose you are a news reporter of a TV channel. You have an assignment to cover the news on the incredible shoes mentioned in the poem. Do a role play of a TV news reporter along with two or three partners as interviewees who will share their imaginary experience of the shoes.

Lesson 4: Walk-in Interview!

Key words : career opportunity maximum negotiable curriculum vitae
 electronic media public opinion public relations positive negative

A Listen to the teacher/CD carefully and fill in the blanks with right word/s.

<p>U8, L4 A Listening text: 9</p>
--

- 1 Newspaper, radio, TV, etc together are called -----.
- 2 Newspaper belongs to -----.
- 3 The media can build up ----- rapidly.
- 4 Social workers should use the media for -----.
- 5 ----- is seen as a positive use of the media.

B Discuss in groups and give arguments in favour of or against the use of ads on TV.

C Look at the following advertisement in a newspaper and answer the following questions.

Job opportunity

Some healthy, young male and female are needed for security work .

- Education** : Class 8,
age : 25 maximum,
experience : not required,
salary : negotiable.

Apply with handwritten CV, 1 copy photograph, and certificate/s on or before 15 June 2015.

Manager,
ABC company Ltd.,
36/A/1 Tejgaon, Dhaka.

Questions

- 1 Who is the employer ?
- 2 Can you type your CV to apply for the job ?
- 3 Who should you apply to ?
- 4 Can a candidate without any experience apply ?
- 5 Can you imagine the size of the photograph you should send with your application ?
- 6 When can the candidate know about his/her salary ?

D Suppose you are going to apply for the job advertised in section C. Use the following model of a CV with your own information. Add at least two more pieces of information.

Curriculum Vitae

- | | |
|-------------------------------|---|
| 1. Name | : |
| 2. Father's name | : |
| 3. Mother's name | : |
| 4. Mailing address | : |
| 5. Date of birth | : |
| 6. Nationality | : |
| 7. Educational qualifications | : |
| 8. Experience | : |
| 9. | : |
| 10. | : |

E If a computer is available at your school, compose the CV and display it in your classroom for everyone.

Lesson 5: A Torch Bearer

Key words: voracious, recognition, legacy, hamper

A Work in pairs to discuss what you see in the picture and answer the following questions.

1. Who is the senior man among the children?
2. Why are the children gathering around him?
3. Do you read story books? How do you collect them?



B Read the following news article.**The Life and Legacy of Polan Sarkar**

Ekushey Padak winner Polan Sarkar, affectionately called *Alor Ferrywala*, a torch bearer, was best known as a kind soul who distributed books for free among people, died on Friday 1st March 2019, but left a legacy that will be remembered for years to come.

The 98-year-old had been suffering from old-age complications. He passed away surrounded by his loved ones at his home of Bausha village in Bagha upazila of Rajshahi. Born in August 1, 1921, Polan Sarkar's real name is Harez Uddin. He was born in Bagatipara, Natore.

Financial troubles of his family could not hamper his passion for reading and learning. He loved books. As a boy, Polan borrowed books from wherever he could, and voraciously read them.

He established a school in his village in 1965 after receiving some inheritance from his grandfather. In 1990, he decided a yearly award for students of the school who would top the merit list. The prize was, of course, books. Other students expressed their desire to read as well. He gave them the condition that the students must return the books to him upon finishing, so he could lend the books to other students as well. Eventually, local adults started borrowing books from his collection as well.

Polan Sarkar started a social movement of distributing books free of charge. When he was diagnosed with diabetes in 1992, he decided he would distribute books during his daily walks. He would go around on his own two feet, sharing his love for books.

He had been admired in Rajshahi for a long time, but gained nationwide recognition after being featured in Bangladesh Television's popular show *Ittadi* in December 29, 2006.

He won the Ekushey Padak in 2011, Bangladesh's second-highest civilian award, for his contribution to society.

(Adapted from: *The Dhaka Tribune*, 1st March 2019)

C The grid below has two columns. Column A has some words taken from the text on Polan Sarkar and Column B has their meaning. Match the words with their meaning. Use a dictionary if needed.

A	B
a. voracious	i. to find out the cause of a disease
b. diagnose	ii. having a great appetite for anything
c. hamper	iii. anything handed down from the past (as from an ancestor or predecessor)
d. inherit	iv. to receive the ownership of a property
e. recognition	v. acknowledgement
f. legacy	vi. to disturb a progress

D Read the text again and answer the following questions:

1. How did Polan Sarkar develop an interest in books?
2. How did he come to be known nationwide?
3. What was Polan Sarkar's contribution to society?
4. When did he decide to walk to the doorsteps of the people for distributing books?
5. How did the adults also become interested in taking books from Polan Sarkar?

E Fill in the blanks using the words given in the box.

see	stands	travels	wake	covers
return	borrow	buys	lends	comes

As the people of the village _____ in the morning, the first thing they _____ is Polan Sarkar. He _____ there, smiling, with a bag of books on his shoulder. He may be all of 94 years, but is sprightly as a young man. He _____ on foot for miles, going from village to village with his books. He _____ the books with his own money and _____ them to the people. After a few weeks, he _____ by again. The villagers _____ the books and _____ from the fresh lot he brings along. He's been doing this for the past 30 years. He _____ about 20 villages in Rajshahi, a district of Bangladesh, starting an innovative reading revolution in the region.

(Adapted from: Impact Journalism Day)

F Work with your partner and make a dialogue on the “Importance of Reading Books”.

G Do you know anyone who is involved in social work like Polan Sarkar? Write a report on him/her using the following cues.

- a. What is his/her name?
- b. Where is she/he from and how old is she/he?
- c. What does she/he do?
- d. Why is she/he famous?
- e. What aspect of her/his personality do you appreciate the most?
- f. What can you do for her/him?

Unit Nine

Things that Have Changed Our Life



After we have studied this unit, we will be able to

- ask and answer questions
- participate in short dialogues and conversations on familiar topics
- read aloud texts with proper sounds, stress and intonation
- read and understand text materials
- write answers to questions
- write short paragraphs

Lesson 1: The Wheel

Key words: circular rotate axis propeller turbine mobility journey (v) vehicle invention civilisation

A Look at the pictures and say which one is easier to move and why.

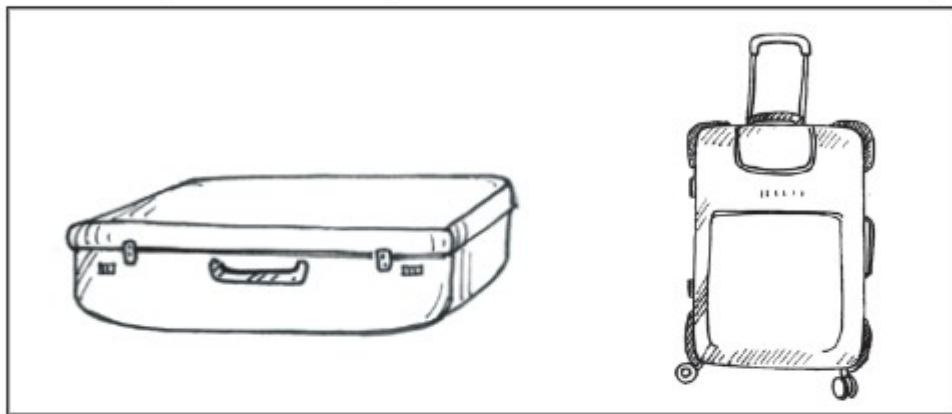

B Read the text and answer the following questions.

Human beings have invented many important things so far. They have brought great civilization to the world through these inventions. Do you know which invention is the greatest? It is 'the wheel'.

A wheel is a circular object. It can rotate around its axis and help easy movement of things across a surface.

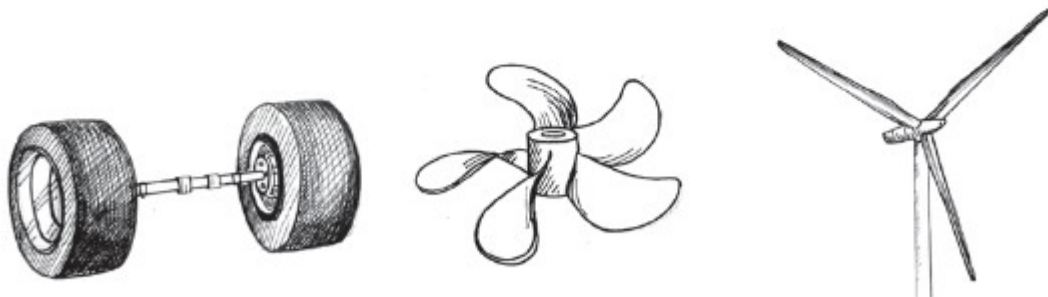

The wheels are, in fact, everywhere. They are on our cars, trains, planes, wagons and so on. Besides, they are on most factory and farm equipment. Fans, propellers, turbines are also other types of wheels.

So the wheel is very important. We cannot imagine modern life without wheels. But do we know exactly who made the first wheel?

Questions

- 1 What is a wheel?
- 2 What can a wheel do?
- 3 Where can you find wheels?

C Fill in the blanks with appropriate words from the box. There are more words than necessary.

difficult much circular important heavy first

Although the wheel is a very (a) ----- invention, the history of its origin is unknown. Experts guess that the first wheel was developed from a circular object. The early man observed that a huge piece of stone could be rolled easily if it was (b) ----- in shape. Similarly, a heavy tree-trunk is (c) ----- to carry; but it can be rolled away with less effort. Even, a gigantic tree-trunk can be moved easily using other small and round trunks as rollers under it. Thus, early man took advantage of rolling objects and developed the (d) ----- wheel. Apart from its mechanical advantage, a wheel's mobility has contributed (e) ----- to the civilisation.

D Make as many correct sentences as you can using the substitution table. In the third column there are more items than necessary.

1. The wheel		a type of wheel.
2. A plain wheel	is	around its axis.
3. It	has	one of the simplest machines.
4. A propeller	rotates	wheels on vehicles and machines.
		helped in rapid progress of civilisation.

E Have you ever travelled by bus or car? Do you have any experience of what happens if one wheel falls flat. If yes, give a description of your experience. If no, imagine such a situation, and write a paragraph on it.

Lesson 2: The History of the Wheel

Key words : invent valley ancient further pioneer warfare

A Look at the following pictures of wheels. They existed in different ages in history. Discuss with your partner and put ordinal numbers under them (in spelling, such as 'first', 'second', etc.,) beginning from the ancient to the modern times.



B Read the following dialogue between the English teacher, Mr Ramis and a student Rubina.

Mr Ramis : You know that the invention of the wheel has helped to create a new civilisation. But do you know who first used wheels?

Rubina : No teacher. But I guess it may be the Greeks.

Mr Ramis : The Greeks were pioneers in many things. But in this case, however, the Mesopotamians were the first. The oldest ever wheel was discovered in Mesopotamia. It was in 3,500 B.C.

Rubina : Where is Mesopotemia?

Mr Ramis : Well, Mesopotamia was in ancient Iraq. It was along the valley of the rivers Tigris and Euphrates. After the Mesopotamians, the wheel was further improved by the Egyptians. They first made wheels with spokes. Then they used them on chariots around 2000 BC.

Rubina : So the wheel travelled to Egypt from Mesopotamia?

Mr Ramis : Exactly. But it travelled eastwards too. Wheels reached the Indus valley by 3000 B.C. But chariots with spoked wheels were made in ancient India in around 1500 B.C. They were used for war, hunting and racing.

Rubina : What about the Greeks,teacher? Didn't they use wheels?

Mr Ramis : They definitely did. In 1500 BC, the Greeks too learnt the idea of wheel-making from the Egyptians. They also made further improvements on it. Later, the Romans did the same too and produced a variety of wheeled vehicles.

C Read the statements below and say whether they are True or False. If False, give the right answer.

- 1 The Greeks were the pioneers in developing spoked-wheels.
- 2 The earliest wheel was discovered in 2000 B.C.
- 3 The Egyptians first used wheels on chariots.
- 4 The Romans first used wheeled chariots for warfare.
- 5 The ancient Indians used wheels before the ancient Romans did.

D Look at the following map of the ancient river-valley civilisations, their locations in the map, and how they are related to wheels. Discuss with your partner.

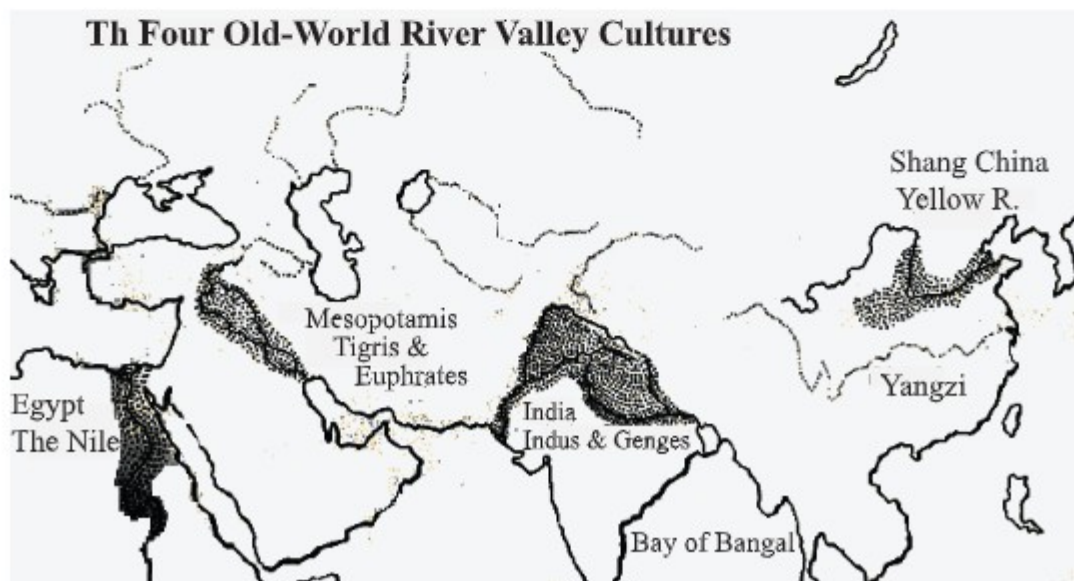

E Listen to the teacher/CD carefully and complete the following sentences with appropriate words.

U9, L2 E
Listening text: 10

- 1 Shang China lies ----- the far east of India.
- 2 The Indus and Ganges valley is ----- the middle.
- 3 The Tigris and Euphrates valley lies ----- the Nile and the Indus-Ganges.
- 4 The Ganges flows ----- the north of India.
- 5 The Bay of Bengal is ----- the east coast of India.

F Discuss in pairs and make as many ‘Wh’ questions as you can from the given answers below. First one is done for you.

- 1 i) *Where does Mesopotamia lie?*
ii) *Which countries does Mesopotamia lie between?*

Ans. Mesopotamia lies between India and Egypt.

- 2

Ans. The Caspian Sea is on the north of Mesopotamia.

- 3

Ans. The Nile falls into the Mediterranean Sea.

- 4

Ans. The river Yangzi lies to the east of India.

- 5

Ans. The Tigris and Euphrates run on the west of Mesopotamia.

G Write a paragraph on the history of the wheel. Take your cues from the dialogue in section B.

Lesson 3: The Fastest Wheel on Earth

Key words : high-speed record-breaking network expand conventional unconventional magnetic trainset

A Look at the pictures of some of the fastest trains on earth and talk about them with your partner.



B Read the text and answer the following questions.

The TGV (*Train à Grande Vitesse*, meaning *high-speed train*) is France's high-speed rail service.

It started in the 1970s. Originally, it was powered by gas turbines. But in 1973, the TGV was changed into electric trains. The TGV service first started between Paris and Lyon in 1981. Later, the network connected other cities in France with Paris.

A TGV test train set the world record for the fastest conventional wheeled train on 3 April 2007. It reached the speed of 574.8 km/h (357.2 m/h) on the test run. But the regular TGV trains operate at the highest speed of 320 km/h (200 m/h). It is the present world record of speed of a conventional commercial train.

The Bullet Train is the network of high-speed train service in Japan. It started operation in 1964 on a limited route. But at present, most major cities of Japan come under the network.

The Bullet Train runs at a maximum speed of 300 km/h (186 m/h). It plans to increase speed up to 320 km/h (200 mph). In 2003, Japan set the world record for unconventional magnetic trainsets. In a test run, the speed was 581 km/h (361 mph). But it is not yet in regular commercial operation.

The High-speed Rail

The High-speed Rail service in China started operation on April 18, 2007. Currently China has started building a high-speed passenger rail network. It will be similar to French TGV or Japanese Bullet Trains. The usual top speed of China's conventional quick trains is 300 km/h (186 mph).

Recently China has set the world record of a speed of 487.3 km/h (303 mph). In 2011, this record was set by an unconventional magnetic *trainset* called the "Harmony Express". This is the highest speed of an unconventional magnetic *trainset* in regular commercial operation.

C Read the above text in section B again. Now discuss with your partner to fill in the blank slots in the following grid with the information about high-speed trains.

Name of the country	Name of the train/train network	Year of introduction/ start	Top speed of conventional train	Top speed of unconventional train	Holds world record for

D Discuss in groups to decide which of the above three rail services you like best and why. Finally write a paragraph and present it to the class.

E Look at the following picture of a railway station in Bangladesh. Now work in pairs.



Dhaka Airport Railway station

Name: Bangladesh Railway

- Headquarter: Dhaka
- Zones: Eastern and Western
- Numbers of stations: 459; number of engines: 284; number of passenger carriages: 1,245; number of wagons: 1,2948
- Total length of railroad: 2,855 kilometres; passengers transported annually: 42 million; total number of employees: 34,168
- Nature of present operations: international (Dhaka-Kolkata); inter-city; local

F Work in pairs. Imagine your partner is a railway official and you are a reporter. You asked questions and the official gave the above information (section E) in answers. Discuss and write what the questions might be.

For example:

- 1 What is the official name of our rail service?
- 2 Where is the headquarters of Bangladesh Railway?

Now continue...

- 1
- 2
- 3
- 4
- 5
- 6

Lesson 4: Taking off

Key words: endeavor supersonic speed revolution aviation ads website
neither ground (v) sky's the limit

A Look at the picture and discuss with your partner what it is and where you can find it.



B Read the text and answer the following questions.

Human beings conquered the distance on earth by discovering wheels. They endeavored further. Then on December 17, 1903, the Wright brothers in America made the first experiment of flying in a plane. In the experiment, a machine carried a man and rose above by its own power. *The machine was called 'aka airplane'*. It flew naturally in a smooth speed, and finally landed without damage. That was human being's first real take-off. And now, they have got a supersonic speed. In a supersonic speed, something travels *faster* than sound! So *the sky's the limit* now!

Modern aircraft companies are making revolutions in aviation technology. Boeing as well as Airbus is producing modern passenger airplanes. These planes fly very fast. Boeing 787 flies 950 km/h. However, Airbus 350 is expected to fly at a speed of 945 km/h.

You find attractive ads on the websites of both Boeing and Airbus planes. Both have excellent features. But in speed, neither could beat the Concorde. It is the



world's *fastest* supersonic passenger aircraft. Its normal speed was 2,170 km/h. The Concorde was a joint project by France and Britain. It started passenger flight in 1976. Unfortunately, the Concorde fleet was grounded forever in 2003 after a major accident.

Questions

- 1 Who made the first successful experiment in flying an airplane?
- 2 What was the first flying machine called?
- 3 What do you mean by 'supersonic'?
- 4 What was world's fastest passenger airplane?
- 5 When was Concorde fleet finally grounded?

Note: The speed of sound, which is approximately 760 miles per hour is called 1 Mach. An airplane flying less than 1 Mach or less than 760 miles per hour is travelling at subsonic speed. Faster than 1 Mach or 760 miles per hour would be a *supersonic speed*.

C Read the dialogue between the English teacher Mr Ramis and Sohan. Then do the following exercise:

Sohan : Teacher, in the last class we read about modern aircraft. There were Boeing 787s, Airbus 350s, Concorde and so on. But which one is the best? Which one can we buy for our Biman Bangladesh Airlines?

Mr Ramis : A difficult question. There are certain things to consider. If you think of speed, Concorde flies the fastest. To many, it looks the most beautiful. But it's no more in operation.

Sohan : Between the other two aircraft?

Mr Ramis : Well, if you remember, Boeing 787 travels 950 km/h. So you see, it's not as fast as Concorde. But it's faster than Airbus 350.

Sohan : Yes, teacher. I remember Airbus 350 travels 945 km/h. It's 5 km shorter than Boeing 787.

Mr Ramis : Nice calculation! But there are other factors too. Say, passenger capacity, production cost and many more. Airbus 380 now is the largest and can carry more passengers than any other aircraft. Authorities have to consider so many...

Sohan : Yes, teacher. I understand.

Complete these statements using the correct form of words in the brackets.

- 1 Airbus 350 is a bit (slow) than Boeing 787.
- 2 Concorde flew the (fast) among all passenger aircrafts.

- 3 Even sound cannot travel as (fast) as Concorde.
- 4 In supersonic speeds, Concorde flies (high) in the sky than Boeing.
- 5 To many, Concorde looks (beautiful) than other passenger aircrafts.
- 6 Airbus A380 is the (large) passenger aircraft in the world now.
- 7 Airbus A380 can carry (many) passengers than Boeing 787.

D Project Work: Work in groups. Suppose, your teacher needs to buy a mobile hand set. Visit in pairs a nearby mobile phone shop. Make a list of different models of handset with their price and other features. Then discuss with your partner to compare and decide which one will be the best handset and why. Share your findings with other groups.

Lesson 5: Future Aircraft

Key words : withstand space base launch detach monitor hypersonic research melting point

A Look at the picture and say what it is. Discuss with your partner.



B Read the news report adapted from The Guardian.

The Falcon Hypersonic Technology Vehicle-2 (Falcon HTV-2) is the fastest plane ever built by human beings. It would fly from London to Sydney in less than an hour. Supersonic Concorde, by the way, could not fly at such a great speed. At the same time it would withstand temperatures of almost 2,000 degree C. This temperature is hotter than the melting point of steel.

The US Defense Agency will launch the Falcon HTV-2. First, they will set it on the back of a rocket. Then they will launch both into the space from an Air Force Base. The plan goes like this: engineers will launch the Falcon HTV-2. into the space on the back of a rocket; then they will detach the plane from the rocket; the plane Falcon will fly towards the Earth; engineers will guide and monitor its flight. The plane would fly at hypersonic speed of 13,000 mp/h. This speed is about 20 times the speed of sound.

The Falcon was born in 2003. It was born as part of a US military project. The project researched and built a special type of plane. The researchers wanted that the plane could reach any part of the world in less than an hour. They also wanted to use it for both military and civil purposes. The plane had already been tested in computer models.

The Falcon Hypersonic Technology Vehicle-2 would be mankind's dream aircraft in the days to come.

Questions

- 1 What is HTV-2?
- 2 What is the speed of HTV-2?
- 3 Describe the steps of HTV-2 test flight.
- 4 Why was the HTV-2 developed?
- 5 Do you think that HTV-2 will be 'mankind's dream aircraft'? Why or Why not?

- C** Imagine you are a TV reporter. You have come to interview the chief engineer of the HTV-2 Launch Project. What questions will you ask him/her? Design a short dialogue between yourself and the engineer, and write it. Finally act it out in pairs with proper sounds, stress and intonation.
- D** Listen to the teacher/CD carefully and complete the following sentences with appropriate words.

U9, L5 D
Listening text: 11

- 1 Thursday's flight will test another ----- of the aircraft.
- 2 The plane is made of ----- composite materials.
- 3 The plane will fly at ----- speed.
- 4 In the flight, the body ----- of the plane could reach 2,000 degree Celsius.
- 5 ----- will melt at 2000 degree Celsius.

- E** The following passage is based on the information in section B. Read the text in B again. Discuss in pairs and complete the following sentences with will/would, can/could/could not.

Even Concorde ----- fly as fast as Falcon HTV-2. The news report says: the US Defense Agency ----- launch the Falcon Hypersonic Technology Vehicle-2 into space. Scientists expect that the Falcon HTV-2 --- ----- fly at 13,000 miles per hour. The US military wishes that the Falcon ----- bomb any part of the world in less than an hour in the future. Engineers plan that they ----- set the Falcon on the back of a rocket to launch it into the distant space.

- F** Have you ever dreamt of flying to a city/country of your choice? If yes, write about your dream. If not, try to imagine you are flying to that place in a plane. Write about your experience and expectations.

If you fly westward in a supersonic plane such as Concorde, you will land several hours before you took off. Can you explain how?

Lesson 6: Paper and Wheel

Key words : record paper surface of stone bark encyclopedia
wood plank digital

A Look at the picture and say what this is. Discuss with your partner.



B Read the text and answer the following questions.

Communication of ideas is at the centre of civilisation. It needs written records. Most of our records in the modern age are on paper. Though writing was invented very early, paper is a more modern invention.

For long, people exchanged ideas through speaking and listening. Then there came the art of writing. But to record thoughts in writing was difficult. Writing materials were not available. People used the surface of stone, metal, wood, bark, leaves, etc. for writing. Those things were not easy to carry. Then for ages, people looked for easy writing materials. Finally, paper was invented in China in 105 CE.

Before the paper age, knowledge was very restricted. Can you think of that time? There were very few books in the world. Maybe, they were written on stone or on heavy wood planks or on metal sheets. Suppose, one page was a heavy stone block. So, think of a hundred-page book! In our time, you can carry the entire world of knowledge in digital form in your laptop. You can even carry a huge volume of paper encyclopedia. But who could produce and carry tons of heavy stone books and documents in those paperless days? In fact, paper has made publication and the spread of knowledge and information easy. So, you can see how paper has changed our life.

Questions:

- 1 How did people exchange ideas before writing was invented?
- 2 Why did people look for easy writing materials?
- 3 Why was knowledge very restricted in the pre-paper age?
- 4 Do you think paper has changed our life? Explain why your answer is 'yes' or 'no'.
- 5 Where was paper invented and when?

C Discuss with your partner and make a list of things other than paper on which we can write in pens, pencils, markers, brushes, paint/pastels etc.

D Listen to the teacher/CD carefully and complete the following sentences.

U9, L6 D**Listening text: 12**

- 1 The person who invented paper is a ----- man.
- 2 He took the bark of a mulberry tree and ----- fibres.
- 3 This knowledge of ----- was first used in China.
- 4 The word 'paper' is not ----- .
- 5 The word 'paper' was derived from a kind of Egyptian plant called -----

E Look at the following boxes first. Listen to the teacher/CD again. Then write in the boxes the series of works Ts'ai Lun' did in making paper. First one and the last one are done for you.

- | |
|--|
| 1. He took the bark of mulberry tree and bamboo fibre. |
| 2. He mixed them |
| 3. He pounded |
| 4. He poured the mixture |
| 5. He let the water..... |
| 6. He let the thing dry. |

- F PROJECT WORK:** On a weekend, observe how *ruti* or *paratha* is made in the kitchen. Carefully take notes of each step taken to make it. Then back in class, share your notes with your partner/group. Finally write how *ruti* or *paratha* is made and make a presentation in the class.

Lesson 7: Contemplation

- A** Look at the picture and discuss in groups the possible answers to these questions.



- 1 Why is the boy up in the tree?
- 2 What is he looking at?
- 3 Guess what he is thinking about.

B Read the poem and answer the following questions.**Contemplation**

For days and days I've climbed a tree
 A dappled yellow tree
 And gazed abroad at many things
 I've always wished to see.

I see the green and gentle fields
 All bounded in with hedge
 And shining rivers swimming through
 The rushes on the edge,
 And little sheep who play all day
 I watch them as they run,
 While far away the roofs of town
 Are shining in the sun.

I think it's very nice to sit
 So high and look so far----
 How very large the world can be!
 How many things there are!

John Carpenter

Note

dappled yellow tree - spotted yellow tree (the leaves may be yellow)

gazed abroad - looked around

bounded - surrounded

hedge - a thick row of bushes

swimming through - (the river like a person is swimming through) flowing through

rushes - tall plants that grow on the river's edge

C Ask and answer these questions.

- 1 Where do you think the tree was?
- 2 What were the four things the poet could see from the tree?
- 3 Have you ever climbed a tree? If yes, what did you do it for? If not, why?

Unit Ten

Fables



After we have studied this unit, we will be able to

- describe pictures
- read and understand texts through silent reading
- infer meaning from context
- ask and answer questions
- take part in discussions
- identify main points of a text

Lesson 1: The Truthful Dove (1)

Key word : shelter grumpy unwillingly generous flattery

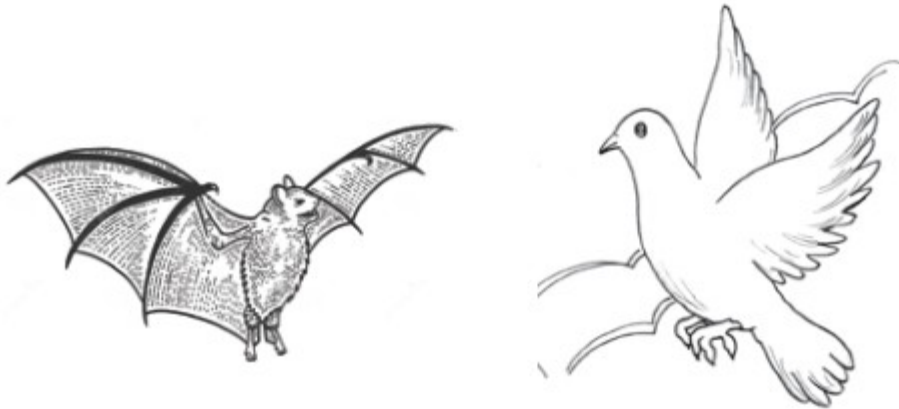

A Talk about the picture and read the story of the dove and the bat.

Once upon a time, a dove and a bat were very good friends. One day the two friends decided to set out on a journey. They flew over the rivers and hills and came to a big jungle. Both the friends were very tired, they needed to sit down and take a rest. Soon night fell and it was dark all around. A storm rose. It started to rain heavily. The dove and the bat started to look for shelter.

They came upon a century-old rain tree. An owl had his nest in that tree. The dove and the bat knocked at the owl's door. The old grumpy owl opened the door. The dove and the bat requested him to give them shelter. The owl unwillingly let them in. The two birds were hungry too. They begged for some food. The selfish owl was not happy. However, he shared his dinner with them. The dove was so tired that she could hardly eat. But the bat was sly. He ate greedily. He began to praise the owl with the thought of getting more food. The bat said, "O wise and brave owl, you are the most generous person I have ever seen. You are powerful and mighty."

The owl was very pleased at the bat's flattery. He puffed and ruffled himself, trying to look as wise and brave as possible. Then he turned to the dove and asked, "Now little dove, what do you think about me?"

B Ask and answer the following questions.

- 1 Who were the two good friends ?
- 2 What did they decide to do ?
- 3 Why were they tired ?
- 4 Why did they look for a shelter ?
- 5 Where did the dove and the bat come ?
- 6 Whose nest was there on the tree?
- 7 Which words tell you that the owl was not good at heart?
- 8 Why couldn't the dove eat?
- 9 Why did the bat praise the owl?
- 10 Which words pleased the owl?
- 11 What action of the owl tells you that he wanted to hear more good things about him?

C Read the story again and make sentences from the table.

The dove and the bat		very tired.
	decided	to fly over rivers and hills.
They	were	to look for a shelter.
		very good friends.

D True or false? If false, give the correct information.

- 1 The dove and the bat decided to go for a flying competition.
- 2 They reached a big jungle.
- 3 They were afraid because a storm was blowing.
- 4 The dove and the bat were looking for a place to spend the night.
- 5 The owl gladly asked the bat and the dove to come in.
- 6 The owl and the birds ate together.
- 7 The bat sincerely praised the owl.

E Which words would you use to describe an eagle or a crow?

Lesson 2: The Truthful Dove (2)

Key words : wondering insincere speech praise host grateful

A Look at the picture and talk about it.



B Read more about the three birds and write answers to the following questions.

All this time the dove was listening to her friend's false praises. She was wondering how insincere his praises were. The dove hung her head down and was quiet. The owl got impatient. He wanted to hear more praises. He looked at the dove and asked, "Don't you have any good thing to say about me?" The bat joined the owl, "Yes, don't you have any words of praise for our kind host?" The dove was ashamed of her friend bat and kept her eyes down. The owl urged the dove, "Come on, say something!"

The dove lifted her head slowly and said, "Master owl, thank you very much for the shelter you have given me, thank you for the food you have offered me. I will remain ever grateful for this".

Questions

- 1 What does the word 'insincere' mean in the story?
- 2 Why did the dove think that the bat is insincere?
- 3 What made the owl impatient?
- 4 Why was the dove ashamed of her friend?

C True or false? If false, give the correct information.

- 1 The bat was very sincere when he praised the owl.
- 2 The owl wanted to hear more good things about himself.
- 3 The dove was very harsh to the owl.

Lesson 3: The Truthful Dove (3)

Key words: gracious noble deserve hospitality ungrateful echo vicious leathery vain

A Look at the picture.



- 1 What do you see?
- 2 How do the three birds look?
- 3 Why do you think they look so?
- 4 Who looks very happy? Can you guess why?

B Read more about the three birds and find out about their fate. Work in pairs and write the answers to the questions that follow.

"What?" cried the bat. "Is that all you have to say to our gracious host? Is he not the wisest, bravest and most generous of all animals and birds? **Don't you have** praise for his noble character as well as for his goodness to us? I am ashamed of you! You do not deserve such hospitality. You do not deserve this shelter."

"You are an ungrateful bird, and the bat is right. You do not deserve this generous hospitality which I have offered. Get out! Be off, I say!" said the owl.

"Yes, get lost!" echoed the bat, flapping his leathery wings. The two heartless creatures fell upon the poor little dove and drove her out into the dark and stormy night.

But the owl and the bat did not go unpunished for their act of heartlessness. The bat can never fly in broad daylight. He has to wait for the sun to go down. And do you know what happened to the vain owl? Well, he is blind as long as the sun is up. He cannot hunt or feed himself unless it is dark. So the two vicious creatures with their dark heart live in the dark.

On the other hand, the dove is rewarded for her truthfulness. Her name shall be used by poets as long as the world lasts to rhyme with "LOVE".

(Adapted from *The Curious Book of Birds* by Abbie Farwell Brown)

Questions

- 1 Why did the bat say that he was ashamed of the dove?
 - 2 Why was the owl angry with the dove?
 - 3 What did the owl and the bat do to the dove?
 - 4 How were the bat and the owl punished at the end?
 - 5 What reward did the dove get?
- C Make a list of the words used in the story to describe the three birds. add some of your own words.**
- Owl :
- Bat :
- Dove :
- D Discuss in groups and write the moral of the story.**

Lesson 4: A Summer Story

A) Look at the image and discuss in groups the possible answers to the questions.



Illustrated by K.G. Subramanyan

1. What comes first in your mind when you look at the image?
2. How do crows actually drink water?

B. Now read this story written by K.G. Subramanyan and answer to the questions that follow:

July, but there was still no sign of rain. Clouds crossed the sky but they only made the heat hotter. I was thirsty. But what could a crow like me do on a day like this? There was no water anywhere. The wells were dry and there were no waterholes. I would have to fly miles and miles to reach anywhere in this heat unless I get to a town.

Crows know that, in times like this, to go where men live is best. They put things by when things are plenty for days when they are scarce. So I flew towards the nearest town over a dry and barren land. When I reached there, it was noon. The streets were empty. The doors were barred. The cisterns and horse-troughs were dry. There was no water anywhere. Except in a small bottle on a pushcart at the street corner. I thanked heaven for that.

But I had thanked too early. How was I going to get the water in the bottle unless I could get my beak in? My beak was too fat and neck of the bottle, too narrow. So, as usual, I went to Grandpa for advice. A doddering old crow he was, but he had seen the world. And, often, had useful things to say. Sure enough, he had a way. Go and get pebbles from the riverbed, he said, and drop them in. When they fill the bottle, the water will come up to the brim for pebbles and water can't be in the same place. This he'd learnt from his old man. And his old man had learnt it from an old Greek crow called Ar-crow-medes

That was great! I didn't even wait to thank him. Off I went to the riverbed where pebbles there were in all shapes and sizes. Pebbles are tricky things for crows to carry. They slip out or slide in. So I had to carry them carefully, piece by piece. On a day like this, it was not easy to do. I panted and sweated and the colour of my wings started to run. And I grew thirstier each time. So, on my last flight, I thought I would carry two together. But that wasn't easy to do either for one would always slip away. Still, I made an effort and carried two some distance. But, as luck would have it, plop went one on the glass roof of the greenhouse. And clitter-clatter went the glass. Not a great loss to me. But, with a shudder came the thought that I could break my bottle, too, with such a pebble. And Grandpa's trick may not work.

That made me mad. I flew helter-skelter. Until, suddenly, I noticed the poster over the bus stop. To think that it had been there all the time and I, like a fool, had never lifted my head to see it. If men can drink through straws, then so can crows. If they are clever. Straws were plenty in the haystacks. I drew a few out, clipped and cleaned them. And used them the way men do. I don't blame Grandpa, though. He was nice in his own way. But each age has its own bag of tricks.

Note

Barren – Land that is dry and unable to produce crops or plants; empty.

Cisterns – Large containers used to hold water.

Barred – Closed off or blocked, preventing entry.

Pushcart – A small cart with wheels used to carry things, often pushed by hand.

Doddering – Moving in an unsteady way, often because of old age; shaky.

Helter-skelter – In a hurried or confused way; chaotic.

Clipped – Cut or trimmed down to a smaller size.

C. Match the correct element with its appropriate description.

Elements	Descriptions
The Crow	A reference to the famous Greek scientist Archimedes.
Grandpa	The modern solution the crow finds by looking at a poster.
Pebbles	The place where the crow finds pebbles to fill the bottle.
Ar-crow-medes	The container with water but too narrow for the crow's beak.
The Bottle	The old crow who offers traditional advice to solve problems.
Straws	The destination where the crow searches for water.
The Greenhouse Incident	The source of the crow's realization about using straws.
The Poster	Where a pebble breaks glass, making the crow rethink its plan.
The Riverbed	The main character of the story who is searching for water.
The Town	The initial method suggested to raise water in the bottle.

D. Answer to the following questions.

1. What problem is the crow facing at the beginning of the story?
2. What advice does Grandpa give the crow to get the water from the bottle?
3. Why does the crow decide not to use pebbles to raise the water in the bottle?
4. How does the crow eventually solve the problem of drinking water from the bottle?
5. What does the crow learn about solving problems by the end of the story?

E. Have you read the original fable about the thirsty crow? Discuss with in groups what changes that the writer has made here.**F. Choose a fable that you like and retell the story using the current context. Then, share it with the class.**

Unit Eleven

Women's Role in Uprisings



Women receiving training to join the fight for Bangladesh's independence in 1971

Learning outcomes:

After we have studied this unit, we will be able to

- describe the significant roles women played in key freedom struggles, including the July Uprising of 2024
- reflect on how women's contributions, often overlooked, redefined possibilities for activism and resistance across eras
- analyse the broader impact of women's efforts on social and political change in Bangladesh.

From the valiant sacrifice of Pritilata Waddedar, who swallowed cyanide pills to avoid capture by British forces in 1932, to the spying and frontline battles of Khasi freedom fighter Kakon Bibi in 1971, women were at the forefront of our struggles for freedom against colonization and oppression.

In 2024, as the country rose against years of repression and autocratic rule, it was again the women who paved the way for a new Bangladesh. They were on the battlefield chanting slogans, stopping police vans, breaking blockades, and taking to the streets at night while men could not. The women were the beacon that penetrated the darkness.



A young woman raises her fist and chants slogans during a protest

Mothers came out with food and supplies tending to injured students defying bullets and tear gas. The student protesters were their children, after all. While men, due to their social position in the hierarchy, were predominantly silent or persecuted, it was the women who spoke up. From domestic workers to grandmothers in mofussils and villages, their words brought down the dictator through daily conversations in both domestic and public spaces. The seeds of freedom were planted through the ordinary speech of our women, who did not shy away from revealing the oppression.



A girl stops a police van carrying arrested students

From domestic workers to grandmothers in mofussils and villages, their words brought down the dictator through daily conversations in both domestic and public spaces. The seeds of freedom were planted through the ordinary speech of our women, who did not shy away from revealing the oppression.

We witnessed initiatives like Mayer Daak, a group of women whose family members had faced enforced disappearances; they became one of the most enduring symbols of defiance and calls for justice during the autocratic rule. They staged demonstrations and faced possibilities of persecution but could not be stopped.



Mayer Daak members demand justice for disappeared family members

Living up to that ideal, female students during the anti-discrimination movement broke out of their dorms, defying the authorities, and shouted at the security forces, calling them murders—“khuni! Khuni!”

It was Abu Sayeed’s mother who asked the question, “amar betak marlu kene?”—a question that reverberated the essence of oppression and triggered resistance in the public imagination. It was the cries of these mothers that truly moved us, making us question the legitimacy of the autocracy that frequently misused women’s liberation narratives as an excuse or token to justify its terrorizing policies.



Illustration: Debashish Roy

It was the mothers and sisters who cut through those narratives. The students from girls' dormitories, the sisters on the streets fighting back, organizing, planning, and strategizing—they were not always in front of the camera and therefore, their struggles and labour are often invisibilized. They worked quietly and fiercely to offer us a new dawn.

A. Answer the following questions based on your reading of the passage:

1. How did women contribute to Bangladesh's freedom struggles in 1932, 1971, and 2024?
2. In what ways did women lead and inspire others during the 2024 uprising?
3. Describe the role of mothers during the 2024 movement and the significance of their actions.
4. What was the impact of initiatives like Mayer Daak, and why did they become enduring symbols of defiance?
5. How did women's voices and actions challenge the narratives used in different regimes?

B. Writing Practice:

Write a paragraph analyzing the overlooked contributions of women in Bangladesh's freedom struggles, as illustrated in the passage. Discuss how women's acts of resistance—from Pritilata Waddedar's sacrifice to the defiant voices of mothers in 2024—have shaped these movements, yet often go unnoticed in traditional histories. Consider how “her story” rather than “history” might more accurately capture the vital roles women played.

C. Group Project: Visual Representation

Create a visual collage or poster series titled “Her Story of Freedom” to capture women's roles in Bangladesh's freedom struggles, focusing on figures like Pritilata Waddedar, Kakon Bibi, and the mothers and students of 2024. Use colours, images, and symbols to highlight their courage and leadership. Accompany your project with a short description, then present it to the class, explaining what you learned about the importance of women's contributions to these movements.

Sample question for JSC examination**Full marks: 100****Time: 3 hours****Marks for individual items are mentioned next to the test items.****A: Seen part****Read the text and answer questions 1 and 2.**

Bangladeshi cuisine is rich and varied with the use of many spices. We have delicious and appetizing food, snacks and sweets.

Boiled rice is our staple food. It is served with a variety of vegetables, curry, lentil soup, fish and meat. Fish is our main source of protein. Fishes are now cultivated in ponds. Also we have fresh-water fishes in the lakes and rivers. More than 40 types of fishes are common. Some of them are *carp*, *ru*, *katla*, *magur* (catfish), *chingri* (prawn or shrimp). *Shutki* or dried fishes are popular. *Hilsha* is very popular among the people of Bangladesh.

Panta-ilish is a traditional platter of *Panta bhat*. It is steamed rice soaked in water and served with a fried *hilsha* slice, often together with dried fish, pickles, lentil soup, green chillies and onion. It is a popular dish on the *Pohela Boishakh*.

The people of Bangladesh are very fond of sweets. Almost all Bangladeshi women prepare some traditional sweets. *Pitha*, a type of sweets made from rice flour, sugar, syrup, molasses and sometimes milk, is a traditional food loved by the entire population. During winter *Pitha Utsab*, meaning *pitha* festival, is organized by different groups of people.

Sweets are distributed among close relatives when there is good news like births, weddings, promotions, etc.

Sweets of Bangladesh are mostly milk-based. The common ones are *roshgolla*, *sandesh*, *rasamalai*, *gulap jamun* and *cham-cham*. There are hundreds of different varieties of sweet preparations. Sweets are therefore an important part of the day-to-day life of Bangladeshi people.

1. Choose the correct answer to each question from the alternatives given and write the corresponding number of the answers in your answer script.

1x7=7

- i) The word 'cuisine' in line 1 of the text means-
- a style of cooking
 - a special kind of food
 - cooking spicy dishes
 - a combination of different dishes
- ii) The words 'appetizing food' in line 1 of the text mean-
- expensive food
 - food that makes you feel hungry
 - food that is cooked with spices
 - food that has good nutritional value
- iii) The word 'platter' in line 8 of the text means-
- a large plate to serve food
 - a meal served on a large plate
 - a dish with a variety of food items on it
 - all of the above
- iv) The main source of protein for Bangladeshi people is-
- boiled rice
 - lentil soup
 - fish
 - meat
- v) *Panta bhat* is usually served with-
- dried fish
 - green chili and onion
 - hilsha
 - all of the above
- vi) *Panta-ilish* is eaten with much festivity
- throughout the year

- b) to the wedding guests
- c) on a special day
- d) in winter
- vii) A popular food item in winter is
 - a) lentil soup
 - b) *pitha*
 - c) *panta bhat*
 - d) dried fish

Answers: i) a, ii) b, iii) d, iv) c, v) d, vi) c, vii) b

2. Answer the following questions from your reading of the above text. 2x4 = 8

- a) Name four fresh water fishes.
- b) How is *panta bhat* prepared?
- c) Name four milk-based sweets.
- d) Where are most of the fish cultivated?

3. Read the following text and fill in the gaps with appropriate words to make it a meaningful one. 1x5 = 5

In a plane, oxygen and the air pressure are always being monitored. In the event of a lack of oxygen, an oxygen mask will automatically (a) _____ in front of you. Pull the mask towards you and (b) _____ it firmly over your nose and mouth. Secure the elastic band behind your head, and breathe normally. If you are travelling with a child or someone who requires (c) _____, secure your mask on first, and then help the other person. Keep your mask on until a uniformed crew member advises you to (d) _____ it. In the event of an (e) _____ please assume the bracing position.

Answers: (a) appear (b) place/put (c) assistance/help/support (d)remove (e) emergency

B: Unseen part

Read the following text and answer questions 4 and 5.

Meera is a singer with a great zeal for folk songs. She is a dancer too. She enjoys dancing with folk songs. She performs at national events and also represents our culture in different countries. Besides singing she also studies Computer Science in a university in China. Manosh and Rudro are also two promising folk singers of our time. Manosh passed the S.S.C examination in 2018 when Rudro was a student of class eight. Manosh won the Star Voice Singing competition in 2012 in the folk song category. Rudro won that award in 2015 in the same category. He performed in the Boishakhi open concert at Dhaka University campus in 2016. Both Manosh and Rudro love folk songs because it appeals to our root culture. They believe that folk music can reach the heart of our common people easily. In 2018 Manosh successfully released his first album titled 'Mon Janala'.

4. Complete the table below. Write no more than three words and/or numbers for each answer.

1 X 5 = 5

Who?	What?	When/where?
Meera	studies Computer Science	in a university in (1)
Meera	(2)	in foreign countries
(3)	was awarded Star Voice Singing competition	in 2012
Rudro	appeared in the Boisakhi concert	at (4) in 2016
Manos	released his maiden album	(5) in

Answers: (1) China (2) represents our culture (3) Manosh (4) Dhaka University campus (5) 2018

5. Read the passage again and write, whether the statements are true or false.

Give correct answers, if the statement is false.

1x5=5

- a) Meera enjoys singing folk songs.
- b) Meera performs at both national and international levels.
- c) Manosh and Rudro won two different awards.
- d) The first album of Manosh was released in the same year when he passed the S.S.C. examination.
- e) The common people of our country love folk songs.

Answers

- a) False. Meera enjoys dancing with folk songs.
- b) True
- c) False. Manosh and Rudro won the same award.
- d) True
- e) True

6. Read the text below and fill-in the gaps using the clues given in the boxes.

There are more words than necessary. One word can be used once only.

$\frac{1}{2} \times 10 = 5$

the	off	as	namely	this	finances
length	cost	country	width	roads	touch

The Padma Multipurpose Bridge is a mega project in the construction history of Bangladesh. This will connect three districts (a) _____, Munshiganj, Shariatpur and Madaripur. With (b) _____ connectivity 21 districts of (c) _____ southwestern part of the (d) _____ will come under direct (e) _____ with the capital as well (f) _____ the whole country. It's total (g) _____ is 6.15 kms. and (h) _____ is 18.1 meters. It will (i) _____ 3.6 billion USD. Bangladesh government (j) _____ this huge project.

Answers: (a) namely (b) this (c) the (d) country (e) touch (f) as (g) length (h) width (i) cost (j) finances

7. Read the text below and fill in the gaps using suitable words to make it a meaningful text.

1x5=5

The sun is the source of all energies. All the living beings (a) _____ sunlight directly or indirectly for their (b) _____ on this earth. Sunlight (c) _____ white as we see it with our naked eyes but the actual (d) _____ of sunlight is green. Now, we are going to explain why sunlight looks white (e) _____ it is originally green.

Answers: (a) use (b) existence (c) looks (d) colour (e) though

8. Match the part of sentences from columns A and B to make five complete sentences.

1x5=5

Column A	Column B
a. One day a fisherman	i. to see the coins as the fisherman returned home
b. Suddenly he saw	ii. began to boast of it before all the friends
c. His wife was very happy	iii. a bag full of gold coins in his net
d. The fisherman asked his wife to keep	iv. cast his net in the river
e. But instead of doing so she	v. the find of gold coins a secret

Answers: a. iv, b. iii, c. i, d. v, e. ii

C: Grammar part

9. Read the text below and fill in the gaps with the root words in the brackets adding suitable suffix, prefix or both.

$\frac{1}{2} \times 10 = 5$

Altaf Mahmud is a musician, (a) _____ (culture) activist and a (b) _____ (free) fighter of Bangladesh. He took part in the historic Language (c) _____ (move) of 1952. He is the (d) _____ (compose) of the famous song "Amar Bhaier Rokte Rangano". He wrote that immortal song to honour the language martyrs of 1952. The songs composed and sung by Altaf Mahmud were great source of (e) _____ (inspire) to the people who protested against the (f) _____ (brutal) of Pakistani Government. Altaf Mahmud was very (g) _____ (support) to those who fought for Bangladesh in the Liberation of 1971. He created a camp inside his house to provide (h) _____ (accommodate) to them. His (i) _____ (patriot) songs were then broadcast from Swadhin Bangla Betar Kendro. He was awarded the Ekushey Padak for his (j) _____ (contribute) to Bengali culture and the War of Liberation.

Answers: (a) cultural (b) freedom (c) movement (d) composer (e) inspiration (f) brutality (g) supportive (h) accommodation (i) patriotic (j) contribution

10. Fill-in the gaps in the following text with appropriate articles (a, an or the).

Put a cross (x) where no article is used.

$\frac{1}{2} \times 10 = 5$

Friendship is one of (a) _____ most precious gifts of life. (b) _____ person who has true friends in life is lucky enough. Friendship makes (c) _____ life thrilling. It is indeed, (d) _____ asset in life. True friendship is (e) _____ feeling of love, sharing and caring. (f) _____ true friends stand by us when we are in trouble. Lasting friendship is indeed, (g) _____ blessing. However, it is better to have friends of (h) _____ same age group and mentality. In short, friendship is (i) _____ essential condition for (j) _____ happy life.

Answers: (a) the (b) a (c) x (d) an (e) a (f) x (g) a (h) the (i) an (j) a

11. Change the following sentences as directed in the brackets.**1x5= 5**

(a) Sylhet is one of the most beautiful districts of Bangladesh. (Make it a comparative sentence). (b) In the 14th century, Saint Hazrat Shah Jalal conquered Sylhet. (Make it a passive sentence). (c) It was declared as a division by the government in 1995. (Make it an active sentence). (d) The vast green tea gardens attract many tourists. (Make it an interrogative sentence). (e) The climate of this place is very fine. (Make it an exclamatory sentence).

Answer: (a) Sylhet is more beautiful than most other districts of Bangladesh. (b) Sylhet was conquered by Saint Hazrat Shah Jalal in the 14th century. (c) The government declared it as a division in 1995. (d) Do the vast green tea gardens attract many tourists? (e) How fine the climate of this place is!

12. Rewrite the following passage changing the form of speech:**5**

“It’s so unusual! It’s a cold night, but I feel warm now,” the Prince said. “It happens when I do something good to help someone,” he added. The Queen smiled to look at his son and said “Good night” “Good night” The Prince also smiled and said to his mom.

Answer: The Prince wondered at the unusual feature of the night because he felt warm even at that time of the cold night. He remarked that it (unusual behavior of the night) happens when he does something good to help someone. The Queen smiled to look at his son and wished him good night. The Prince also smiled at her mom as he said her good night.

13. Use capital letters and punctuation marks as needed in the following passage.**½ X10=5**

one day Neela went to see bela her elder sister bela she found her very depressed there Neela asked what happens darling

Answer: One day Neela went to see Bela, her elder sister. She found her very depressed there. Neela asked, “What happens, darling? “

D: Writing part

14. Suppose you are Rabid and you are in a restaurant with your sister. Make a dialogue between you and the waiter before ordering your meal. 10

Answer (sample only):

- | | |
|--------|---|
| Waiter | Can I help you? |
| Rabid | A table for two please. |
| Waiter | You can take this table, sir. |
| Rabid | Thanks, this is a nice corner table. |
| Waiter | Are you ready to order? |
| Rabid | Yes, we'll have the cashew nut salad, a Thai soup and a serve of fried rice with chili chicken. |
| Waiter | Anything to drink? |
| Rabid | Just water for me and a lemonade for my sister, please. |
| Waiter | Is that all, sir? |
| Rabid | Yes, I think, that's all for now. Thank You. |

15. A social organisation in your locality is hiring some volunteers for a fund raising event. Write an email to the coordinator of that organisation to be a volunteer for the event. The email can be sent to abcd123@charity.org.bd. In your email, you should 10

- write a subject line
- use proper salutation/greetings
- give a brief introduction of you
- express your interest for the role of a volunteer
- mention why you are interested to work as a volunteer
- write a closing remark, your name, address and phone

Sample answer

To: abcd123@charity.org.bd

Subject: Interested to be a volunteer

Dear sir/madam,

I am a student of class eight at ABC Boys High School, Pabna. I have seen your advertisement about hiring volunteers for your charity event. I am really interested to work as a volunteer for that event.

I always look for opportunities to help the poor and helpless people in our society. Moreover, I enjoy working with like-minded people in a team.

I hope to hear from you soon.

Thanking you,

Mohamad Zaif
123, Road, Pabna

16. Write a paragraph of 250 words on the advantages and disadvantages of nuclear families. Your writing should address the following questions:

10

- What is a nuclear family?
- What are the advantages of a nuclear family?
- What are the disadvantages of a nuclear family?
- What kind of family do you prefer, why?

-----○-----

Sample question for JSC examination**Full marks: 100****Time: 3 hours****Marks for individual items are mentioned next to the test items.****A: Seen part****Read the text and answer questions 1 and 2.**

Good afternoon passengers. This is your captain Rashid Akbar speaking. First I'd like to welcome everyone on Flight BG 88. We are currently cruising at an altitude of 10058.40 feet at airspeed of 643.7376 km per hour. The time is 1:25 pm. The weather looks good and with the tailwind on our side we are expecting to land in Bangkok approximately fifteen minutes ahead of schedule. The weather in Bangkok is clear and sunny. The temperature is 32 degrees Celsius for this afternoon. If the weather is good, we should get a great view of the city as we descend. The cabin crew will be coming around in about twenty minute's time to offer you a light snack and drinks. The inflight movie will begin shortly after that. I'll talk to you again before we reach our destination. Until then, sit back, and enjoy the flight.

1. Now choose the correct answer to each question from the alternatives given and write the corresponding number of the answers in your answer script.

1x7=7

- i) What is the job of Rashid Akbar?
- a) Cabin Crew
 - b) Announcer
 - c) Pilot
 - d) An army officer
- ii) The word cruise means-
- a) moving ahead
 - b) moving fast
 - c) travelling at a steady speed
 - d) None of the above

iii) The word "tailwind" means -

- a) wind blowing from behind a moving vehicle
- b) wind coming from front
- c) the wind that blows around the tail
- d) the wind that propels the tail

iv) What is the objective of the announcer?

- a) to call everyone's attention
- b) to warn the passengers
- c) to begin a communication
- d) to give necessary information

v) When can the passengers get the view of the city?

- a) within fifteen minutes
- b) as the flight comes down
- c) all through the flight in the sky
- d) immediately after the announcement

vi) Passengers will be treated with some light refreshment within

- a) 15 minutes
- b) 20 minutes
- c) 25 minutes
- d) 32 minutes

vii) Where is the temperature 32 degree Celsius?

- a) inside the plane
- b) outside the plane
- c) Bangkok
- d) In departure city

Answers

i) c ii) a iii) a iv) d v) b vi) b vii) c

2. Answer the following questions from your reading of the text above.**2x 4 = 8**

- a) Where is the flight now?
- b) What destination is the flight bound for?
- c) When will the in-flight movie begin?
- d) Why did the announcer describe the weather?

3. Read the following text and fill in the gaps with contextually appropriate words**1X5=5**

River gypsies are an ethnic group of people in Bangladesh. They are known as *beday* to (a) _____ people. The (b) _____ have their own lifestyle and (c) They live in groups and do not (d) _____ any land. Therefore, they live a nomadic life, (e) _____ from one place to another.

Answers: (a) local (b) gypsies (c) culture (d) own/have
(d)travelling/moving/roaming/shifting (e) roam/move/travel

B: Unseen part**Read the following text and answer questions 4 and 5.**

The current world population roughly calculated by the United Nations is 7.5 billion as of September 2017. Six of the seven continents of the Earth are permanently resided on a large scale. Asia is the most populous continent, with its 4.54 billion inhabitants accounting for 60% of the world population. China and India are world's most populated countries. They together have about 37% of the world's population. Africa is the second most populated continent, with around 1.28 billion people and it is 16% of the world's population. The population of Europe is 742 million which is 10% of the world's population as of 2018, while 651 million live in the Latin America and Caribbean regions and it is 9% of the world's population. Northern America primarily consisting of the United States and Canada has a population of around 363 million which is 5% and Oceania is the least-populated region with about 41 million inhabitants which is 0.5% of world population although it is not permanently resided by any fixed population. Antarctica has also a small and varied international population based mainly in polar science station.

4. Complete the grid below with appropriate information.**1X5=5**

Continent/ Country	Population	% of world population
Asia	4.5 billion	i).....
Africa	ii).....	16%
iii)	742 million	10%
U.S.A and Canada	iv).....	5%
Oceania	41 million	v)..... ..

Answers: i) 60% ii) 1.28 billion iii) Europe iv) 363 million v) 0.5%

5. Read the passage again and write, whether the statements are true or false. Give correct answers, if the statement is false.

1x5=5

- Asia has the largest population among all the seven continents.
- Africa is in the third position in case of the number of population.
- The number of population in Europe is the same as in Asia.
- The United States and Canada are the North American countries.
- In Oceania and Antarctica, the number of population rises and falls.

Answers

- True
- False. Africa is in the second position in case of the number of population.
- False The number of population in Europe is less than that of Asia.
- True
- True

6. Read the text below and fill in the gaps using clues from the boxes. There are more words than necessary. **½ X10=5**

connectivity	remains	cannot	without	among	
Pandora	for	education	strange	made	dimension

Mobile phone is a wonderful invention of modern science. It has added a new (a) _____ to our everyday life. People (b) _____ think of a single moment (c) _____ a mobile phone. It has (d) _____ life easier by increasing our (e) _____. No doubt the world now (f) _____ in our pocket through this (g) _____ device. It is really a (h) _____ box which can be used (i) _____ different purposes like entertainment to (j) _____.

Answers

(a) dimension (b) cannot (c) without (d) made (e) connectivity (f) remains (g) strange (h) Pandora (i) for (j) education

7. Read the text below and fill in the gaps with words that are appropriate.

1X5=5

The world is changing every day. People are constantly moving to different (a) _____ for different reasons. So people need (b) _____ journey. People also need speed. Wheels (c) _____ made it possible. This is why, (d) _____ of wheels is so important to (e) _____.

Answers

(a) destinations (b) comfortable (c) have (d) invention (e) us.

- 8. Match the part of sentences from columns A and B to make five complete sentences. Column B has one more options than required. 1x5=5**

Column A	Column B
a. Once upon a time there was a king	i. went everywhere on foot.
b. He was extremely	ii. to invent some kind of seat that could move by itself.
c. Being afraid of riding horse he	iii. who was known as Prudence.
d. Naturally, his soldiers and ministers	iv. cautious and very nervous as well.
e. At last, they went to a magician and requested him	v. had to walk on foot too.
	vi. To go home.

Answers

a. iii b. iv c. i d. v e. ii

C: Grammar part

- 9. Read the text below and fill in the gaps with the root words in the brackets adding suitable suffix, prefix or both. ½ x10=5**

Visa, the global payment solutions (a) _____ (provide) will introduce (b) _____ (contact)_cards in Bangladesh this year. These cards do not have (c) _____ (paid) system and allow customers to make (d) _____ (pay) simply by waving the card near the point of sales machine. It needs no (e) _____ (insert) of the card into the machine. The cards provide customers with improved and (f) _____ (speed) transaction. It will be (g) _____ (fast) and offer increased protection from card fraud than (h) _____ (tradition) cards. Such payment solution will add (i) _____ (secure) to card service (j) _____ (significant).

Answers:

a) provider b) contactless c) prepaid d) payment e) insertion
f) speedy g) faster h) traditional i) security j) significantly

10. Fill in the gaps of the following text with appropriate articles (a, an or the).**Put a cross (x) for zero article.****½ x10=5**

(a)_____ violent storm hit Netrokona district last week. The storm blew at (b)_____ speed of 150 km per hour. It hit 12 villages and demolished almost all (c)_____ houses of those villages. It caused (d)_____ severe damage. All (e)_____ the electric poles were blew up and as a result there was a power-cut. People had to remain in darkness for over (f)_____ week. It was (g)_____ unbearable situation for them. (h)_____ poor suffered (i)_____ lot. It was really (j)_____ terrible storm.

Answers: (a) a (b) a (c) the (d) x (e) the (f) a (g) an (h) the (i) a (j) a

11. Change the following sentences as directed in the brackets.**1x5=5**

(a) Dhaka was founded by the Mughals in the 17th century. (Make it an active sentence).
 (b) The Mughals governed the region during the early modern period. (Make it an interrogative sentence).
 (c) The Mughals constructed many buildings here. (Make it a passive sentence).
 (d) Ahsan Manjil is one of the attractive buildings. (Make it an exclamatory sentence).
 (e) Nila is yet to visit Dhaka (make it a negative sentence in terms of sentence construction).

Answer: (a) The Mughals founded it in the 17th century. (b) Did the Mughals govern the region during the early modern period? (c) Many buildings were constructed here by the Mughals. (d) What an attractive building the Ahsan Manjil is! (e) Nila did not visit Dhaka yet.

12. Rewrite the following passage changing the form of speech:**5**

Sakina said to Himel, "How are you? I went to your house yesterday but you were not there." "I went to a shop," said Himel, "I had to buy some dresses for my sister."

Answer: Sakina asked Himel how he was. She told him that she had gone to his house the previous day but he was not there. Himel replied that he had gone to a shop and added that he had to buy some dresses for his sister.

13. Use capital letters and punctuation marks as needed in the following passage.

.5X10=5

daniel defoe the writer of robinson crusoe was born in london in 1660 defoe started to write when he was a young man the idea for writing the great story came from the story of alexander selkirk when he was at the age of 59

Answer: Daniel Defoe, the writer of Robinson Crusoe was born in London in 1660. Defoe started to write when he was a young man. The idea for writing the great story came from the story of Alexander Selkirk when he was at the age of 59.

D: Writing part

14. Suppose you are Samiya and chatting with your cousin, Subarno. Make a dialogue with him/her about folk songs.

10

Key (This is just an example.)

- | | |
|---------|---|
| Samiya | Ah, you are listening to music! |
| Subarno | Oh, yes. You know Samiya, I'm so fond of music. |
| Samiya | I know. But I'm not sure what type of music you like. |
| Subarno | To be honest, I like Bangla folk music. |
| Samiya | Great. Please tell me about the folk songs. I know little about it. |
| Subarno | Ok, the folk songs are the traditional songs of Bangladesh. It is sung by the common people of the country. It is simple in terms of theme, tunes, lyric or melody. Polligiti, bhatiyali, lolongiti are some of our popular folk songs. |
| Samiya | Can you tell me about some famous folk singers? |
| Subarno | Sure, Hason Raja, Abbasuddin, Abdul Alim, or recent Momtaj Begum, Firoj Shai, Dilruba Khan are some famous folk singers. You must listen to them. |
| Samiya | Ok. I'll. |

15. You have invited some of your friends to a get together at your place. Unfortunately, you are unable to hold the event as you have fallen sick. Write an email to one of your invited friends telling that the event is postponed now. You may send the email to abcd123@gmail.com. In your email, you should

10

- write a subject line
- use proper salutation/greetings
- tell that the event is postponed
- give reasons for the postponement
- regret for the unfortunate situation
- write a closing remark
- write your name

Sample answer

To: abcd123@gmail.com

Subject: Get together postponed

Hello X,

Hope you are doing well. I am passing horrible time as I have been fighting a nasty viral flu since last week. That means we are not going to get together this weekend. I am extremely sorry for cancelling the event.

I hope you will understand my situation. We may think about a new date when I come round.

Please pray for my recovery.

Best regards,

Y

16. Write a paragraph on your favourite movie/TV programme. You have to write what the movie/programme is about, why you like it, and what your learning is from this movie/programme.

The End

2025 Academic Year

Dakhil Eight – English For Today

Necessity is the mother of invention.

